



Extreme Performance from Rexnord

## Leaf chains RexAthletic

**REXNORD**



**RexAthletic**

good loading capacity  
extended lubrication intervals



## RexAthletic

Extreme Performance from Rexnord.

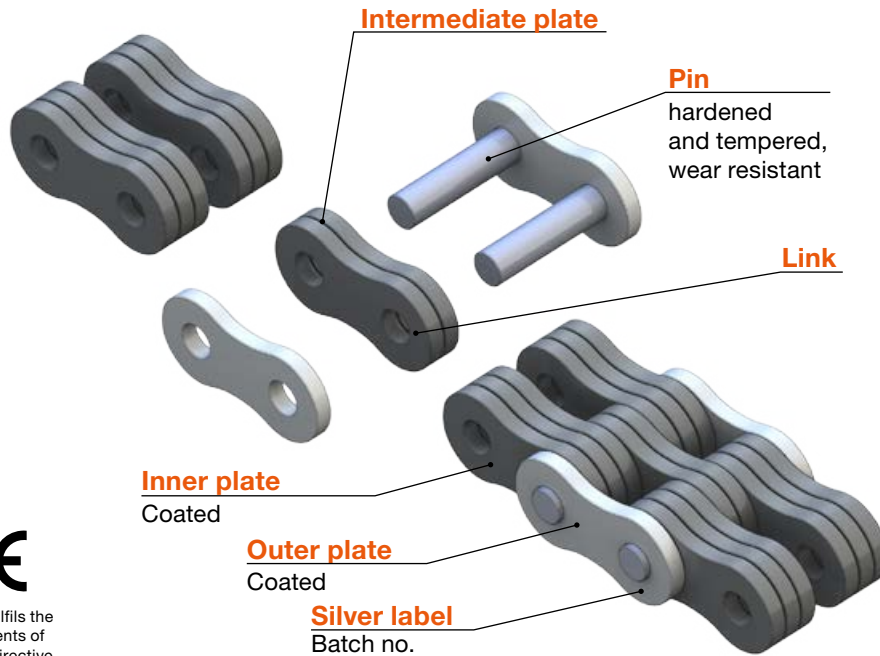

Rexnord fulfils the requirements of Machine Directive 2006/42/EC

### APPLICATIONS

- Forklift trucks, telehandlers
- Material handling
- Machine tools

### CHARACTERISTICS

- Silver colored outer plates for visual differentiation
- RexAthletic version available on request for all leaf chains in the AL, BL and F Series in accordance with ISO 4347 and works standard chains

### ADVANTAGES

- Significantly longer relubrication intervals
- Dimensions and mechanical properties such as tensile strength and fatigue strength
- Wear resistance increased by a factor of 2
- Label number for better traceability
- Eco friendly: reduced lubricant requirement
- Low noise level for increased workplace safety and comfort
- Compatible replacement for all standard chains

### LUBRICATION

- Operating temperature: -15°C to +55°C
- Special long-life lubricant optimized by Rexnord

# RexAthletic

Extreme Performance from Rexnord.



**Improved wear resistance**

- Significantly longer relubrication intervals
- Special long-life lubricant optimized by Rexnord
- Service life now doubled
- High operating reliability



**High fatigue resistance**

- Ball-drifted plate holes
- Shot-peened chain components
- High pre-loading



**Eco-friendly**

- No heavy metals; Teflon- and silicone-free
- Environmental management system conforms to DIN EN ISO 14001



## Number of cycles before relubrication is necessary

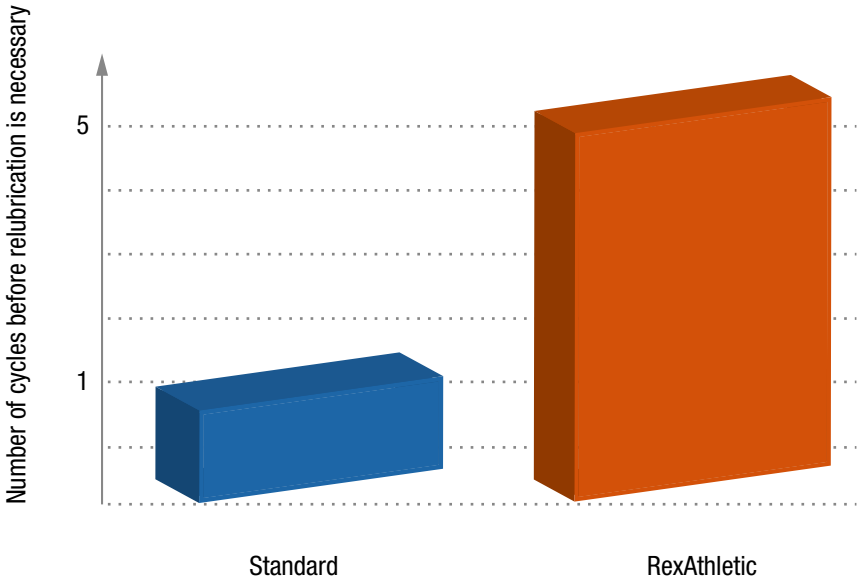

Rexnord fulfils the requirements of Machine Directive 2006/42/EC

## RexAthletic - American type, Heavy series

Extreme Performance from Rexnord.



### Improved wear resistance

- Significantly longer relubrication intervals
- Special long-life lubricant optimized by Rexnord
- Service life now doubled
- High operating reliability



### High fatigue resistance

- Ball-drifted plate holes
- Shot-peened chain components
- High pre-loading



Rexnord fulfils the requirements of Machine Directive 2006/42/EC



### Eco-friendly

- No heavy metals; Teflon- and silicone-free
- Environmental management system compliant with DIN EN ISO 14001

Table 1 of 2

## Leaf chains DIN ISO 4347 (DIN 8152)

Chain No.	ISO chain number	Pitch		Lacing	Pin diameter				Plate depth	Thickness of plates	Length over 100 pitches.	Overall width	Bearing area	Width between outer plates	Required min. tensile strength ISO	Rexnord min. tensile strength	Fatigue strength	Weight			
		p			d <sub>1</sub> max.	g max.	s	■													
		inch	mm		mm	mm	mm	mm													
BL 523	LH 1023	0.625	15.875	2 x 3	5.94	14.6	2.4	1596	15.0	0.43	7.4	33 400	40 000	10 500	1.1						
BL 534	LH 1034			3 x 4					20.0	0.57	12.3	48 900	60 000	11 500	1.5						
BL 544	LH 1044			4 x 4					22.5	0.57	14.7	66 700	80 000	12 000	1.8						
BL 546	LH 1046			4 x 6					27.3	0.86	19.5	66 700	80 000	14 000	2.2						
BL 566	LH 1066			6 x 6					32.3	0.86	24.6	100 100	120 000	15 200	2.6						
BL 588	LH 1088			8 x 8					42.2	1.14	34.3	133 600	160 000	17 000	3.4						
BL 622	LH 1222			2 x 2					0.75	19.05	7.92	17.9	3.1	1905	16.6	0.51	6.4	48 900	62 000	13 000	1.5
BL 623	LH 1223			2 x 3											19.9	0.74	9.6	48 900	62 000	16 300	1.8
BL 634	LH 1234	3 x 4	26.5	0.98	16.0	75 600	93 000	17 400							2.5						
BL 644	LH 1244	4 x 4	29.7	0.98	19.2	97 900	124 000	19 000							2.9						
BL 646	LH 1246	4 x 6	36.3	1.47	25.6	97 900	124 000	21 500							3.6						
BL 666	LH 1266	6 x 6	42.7	1.47	32.0*	146 800	186 000	24 500							4.3						
BL 822	LH 1622	2 x 2	1.00	25.4	9.53	23.6	4.0	2540							20.6	0.76	8.2	84 500	110 000	22 000	2.4
BL 823	LH 1623	2 x 3													24.8	1.14	12.3	84 500	110 000	30 000	3.0
BL 834	LH 1634	3 x 4							33.1	1.53	20.5	129 000	165 000	32 000	4.2						
BL 844	LH 1644	4 x 4							37.3	1.53	24.6	169 000	220 000	33 500	4.8						
BL 846	LH 1646	4 x 6							45.6	2.29	32.9	169 000	220 000	38 500	6.0						
BL 866	LH 1666	6 x 6							54.1	2.29	41.3	253 600	330 000	42 000	7.2						
BL 888	LH 1688	8 x 8							70.8	3.05	57.9	338 000	440 000	45 000	9.6						
BL 1023	LH 2023	2 x 3							1.25	31.75	11.10	29.2	4.7	3179	28.9	1.57	14.4	115 600	164 000	47 500	4.4
BL 1034	LH 2034	3 x 4	38.7	2.09	24.1	182 400	246 000	50 000							6.2						
BL 1044	LH 2044	4 x 4	43.6	2.09	29.0	231 200	328 000	55 000							7.0						
BL 1046	LH 2046	4 x 6	53.6	3.13	38.5*	231 200	328 000	62 000							8.7						
BL 1066	LH 2066	6 x 6	63.4	3.13	48.6*	347 000	492 000	69 000							10.5						
BL 1088	LH 2088	8 x 8	83.1	4.18	68.2	462 400	656 000	74 000							13.9						

\* Please contact us regarding precision of fit with ISO anchors

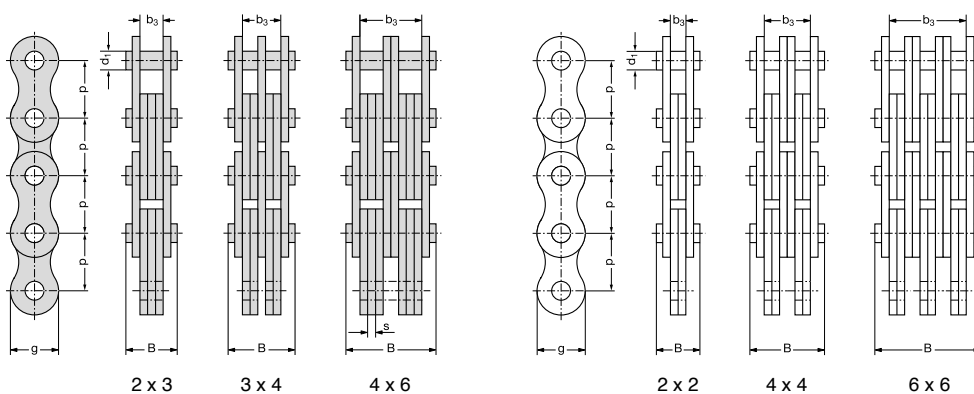

# RexAthletic - American type, Heavy series

Extreme Performance from Rexnord.



### Improved wear resistance

- Significantly longer relubrication intervals
- Special long-life lubricant optimized by Rexnord
- Service life now doubled
- High operating reliability



### High fatigue resistance

- Ball-drifted
- Shot-peened chain components
- High pre-loading



### Eco-friendly

- No heavy metals; Teflon- and silicone-free
- Environmental management system compliant with DIN EN ISO 14001



Rexnord fulfils the requirements of Machine Directive 2006/42/EC

Table 2 of 2

## Leaf chains DIN ISO 4347 (DIN 8152)

Chain No.	ISO chain number	Pitch		Lacing	Pin diameter			Length over 100 pitches.	Overall width		Bearing area	Width between outer plates	Required min. tensile strength ISO	Rexnord min. tensile strength	Fatigue strength	Weight					
		p	mm		d <sub>1</sub> max.	g max.	s		B max.	A							b <sub>3</sub> min.	F <sub>U</sub>	F <sub>B</sub>	F <sub>D</sub>	q
BL 1223	LH 2423	1.50	38.1	2 x 3	12.70	34.4	5.5	3810	33.6	2.1	16.8	151 200	200 000	64 000	6.0						
BL 1234	LH 2434			3 x 4					45.5	2.8	28.0	224 600	300 000	68 000	8.3						
BL 1244	LH 2444			4 x 4					51.2	2.8	33.6	302 400	400 000	72 000	9.5						
BL 1246	LH 2446			4 x 6					62.7	4.2	44.8	302 400	400 000	82 000	11.8						
BL 1266	LH 2466			6 x 6					74.5	4.2	56.0*	453 600	600 000	90 000	14.1						
BL 1288	LH 2488			8 x 8					97.8	5.4	78.4	604 800	800 000	98 000	18.8						
BL 1423	LH 2823	1.75	44.45	2 x 3	14.27	40.8	6.3	4445	38.2	2.7	19.2	191 300	250 000	8.3							
BL 1434	LH 2834			3 x 4					51.7	3.6	32.0	315 800	375 000	11.6							
BL 1444	LH 2844			4 x 4					58.2	3.6	38.4	382 600	500 000	13.2							
BL 1446	LH 2846			4 x 6					71.5	5.4	51.2	382 600	500 000	16.4							
BL 1466	LH 2866			6 x 6					85.0	5.4	64.0*	578 000	750 000	19.7							
BL 1488	LH 2888			8 x 8					111.7	7.2	89.6	765 200	1 000 000	25.9							
BL 1623	LH 3223	2.00	50.8	2 x 3	17.46	47.9	7.0	5080	42.1	3.67	21.3*	289 100	360 000	11.0							
BL 1634	LH 3234			3 x 4					57.0	4.89	35.5*	440 400	540 000	15.4							
BL 1644	LH 3244			4 x 4					63.8	5.0	42.6*	578 200	720 000	17.5							
BL 1646	LH 3246			4 x 6					78.9	7.33	56.8*	578 200	720 000	21.8							
BL 1666	LH 3266			6 x 6					95.0	7.33	73.7*	867 400	1 080 000	26.2							
BL 1688	LH 3288			8 x 8					125.6	9.78	103.5	1 156 400	1 440 000	34.9							

MODULE\_08/GB/2014/08 // No liability accepted for misprints or errors!

\* Please contact us regarding precision of fit with ISO anchors.

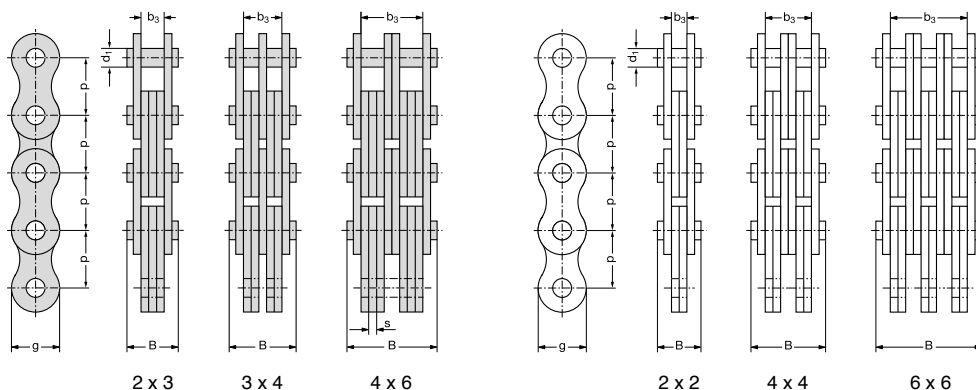

## Recommended chain anchor dimensions for connecting leaf chain inner links

## Connecting pin for joining leaf chains to chain anchor

Chain No.	Inner link connector dimensions Dimensions in mm									
	f	b	c	d <sub>1</sub>	e	r <sub>1</sub>	r <sub>2</sub>			
	max.	min.	max.	D 10	min.	max.	max.			
BL 522	12.7	5.0	–	6.0	11.0	8.0	2.0			
BL 523	14.9	7.5	–				2.0			
BL 534	19.9	5.0	2.4				2.0			
BL 544	22.4	5.0	4.8				2.0			
BL 546	26.9	7.5	4.8				2.0			
BL 566	31.9	5.0	4.8				2.0			
BL 588	42.4	5.0	4.8				2.0			
BL 623	19.9	10.3	–				8.0	14.0	9.5	5.0
BL 634	26.9	6.8	3.2	3.0						
BL 644	29.9	6.8	6.4	3.0						
BL 646	36.9	10.3	6.4	3.0						
BL 666	42.9	6.8	6.4	3.0						
BL 688	56.4	6.8	6.4	3.0						
BL 823	24.9	12.8	–	9.6	18.0	12.5				6.0
BL 834	32.9	8.5	4.0							4.0
BL 844	36.9	8.5	8.0				4.0			
BL 846	45.9	12.8	8.0				6.0			
BL 866	52.9	8.5	8.0				4.0			
BL 888	69.4	8.5	8.0				4.0			
BL 1023	69.4	15.1	8.0				11.2	22.0	15.0	4.0
BL 1034	39.0	10.0	4.7							5.0
BL 1044	44.0	10.0	9.4	5.0						
BL 1046	54.0	15.1	9.4	7.0						
BL 1066	63.0	10.0	9.4	5.0						
BL 1088	79.7	10.0	9.4	5.0						
BL 1223	34.3	17.7	–	12.8	26.0	19.0				8.0
BL 1234	46.0	11.8	5.5							5.0
BL 1244	51.7	11.8	11.0				5.0			
BL 1246	63.3	17.7	11.0				8.0			
BL 1266	75.1	11.8	11.0				5.0			
BL 1288	98.4	11.8	11.0				5.0			
BL 1423	38.5	20.1	–				14.3	31.0	22.0	10.0
BL 1434	52.0	13.4	6.3							6.0
BL 1444	58.4	13.4	12.6	6.0						
BL 1446	71.5	20.1	12.6	10.0						
BL 1466	84.9	13.4	12.6	6.0						
BL 1623	42.8	22.5	–	17.5	34.0	25.0				10.0
BL 1634	57.7	15.0	7.1							7.0
BL 1644	65.4	15.0	14.2							7.0
BL 1646	79.6	22.5	14.2				10.0			
BL 1666	94.3	15.0	14.2				7.0			
BL 1688	123.7	15.0	14.2				7.0			

Chain No.	Connecting pin order no.	Connecting pin Dimensions in mm					
		l min.	L max.	d max.	d <sub>2</sub>		
		BL 522	709 – 355 – 22	12.8	19.4	5.94	2.0
BL 523	709 – 355 – 23	15.0	21.6				
BL 534	709 – 355 – 34	20.0	26.6				
BL 544	709 – 355 – 44	22.5	29.1				
BL 546	709 – 355 – 46	27.0	33.7				
BL 566	709 – 355 – 66	32.0	38.7				
BL 588	709 – 355 – 88	42.5	49.3				
BL 623	709 – 307 – 23	20.0	30.7	7.92	3.2		
BL 634	709 – 307 – 34	27.0	37.7				
BL 644	709 – 307 – 44	30.0	40.7				
BL 646	709 – 307 – 46	37.0	47.7				
BL 666	709 – 307 – 66	43.0	53.7				
BL 688	709 – 307 – 88	56.5	67.2				
BL 823	709 – 309 – 23	25.0	35.7			9.53	3.2
BL 834	709 – 309 – 34	33.0	43.7				
BL 844	709 – 309 – 44	37.0	47.7				
BL 846	709 – 309 – 46	46.0	56.7				
BL 866	709 – 309 – 66	53.0	63.7				
BL 888	709 – 309 – 88	69.5	80.3				
BL 1023	709 – 311 – 23	30.0	42.4	11.1	4.0		
BL 1034	709 – 311 – 34	39.2	51.6				
BL 1044	709 – 311 – 44	44.2	56.6				
BL 1046	709 – 311 – 46	54.2	66.6				
BL 1066	709 – 311 – 66	63.2	75.6				
BL 1088	709 – 311 – 88	79.9	92.4				
BL 1223	709 – 312 – 23	34.5	46.9			12.7	4.0
BL 1234	709 – 312 – 34	46.2	58.6				
BL 1244	709 – 312 – 44	51.9	64.4				
BL 1246	709 – 312 – 46	63.5	76.0				
BL 1266	709 – 312 – 66	75.3	87.8				
BL 1288	709 – 312 – 88	98.6	111.1				
BL 1423	709 – 314 – 23	38.7	51.1	14.27	4.0		
BL 1434	709 – 314 – 34	52.2	64.6				
BL 1444	709 – 314 – 44	58.6	71.1				
BL 1446	709 – 314 – 46	71.7	84.2				
BL 1466	709 – 314 – 66	85.1	97.7				
BL 1623	709 – 317 – 23	43.1	60.6			17.46	5.0
BL 1634	709 – 317 – 34	58.0	75.5				
BL 1644	709 – 317 – 44	65.7	82.9				
BL 1646	709 – 317 – 46	79.9	97.4				
BL 1666	709 – 317 – 66	94.6	112.2				
BL 1688	709 – 317 – 88	124.0	141.6				

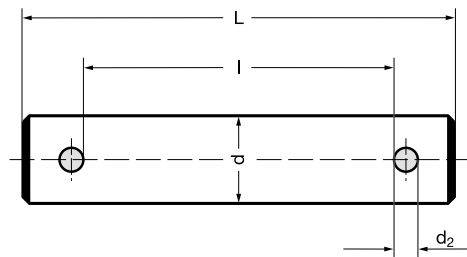
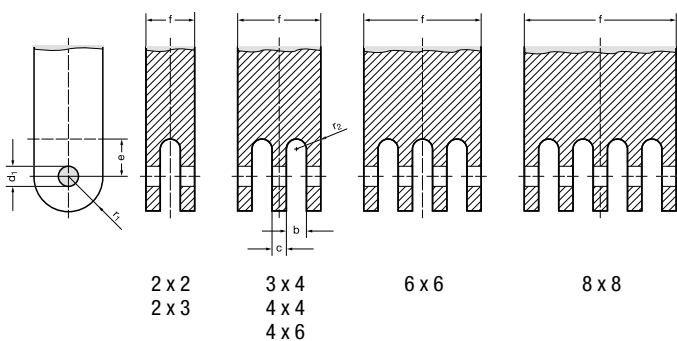

All pins are fitted with 2 cotters and – from BL 1234 and F 38 upwards – with 2 additional washers.

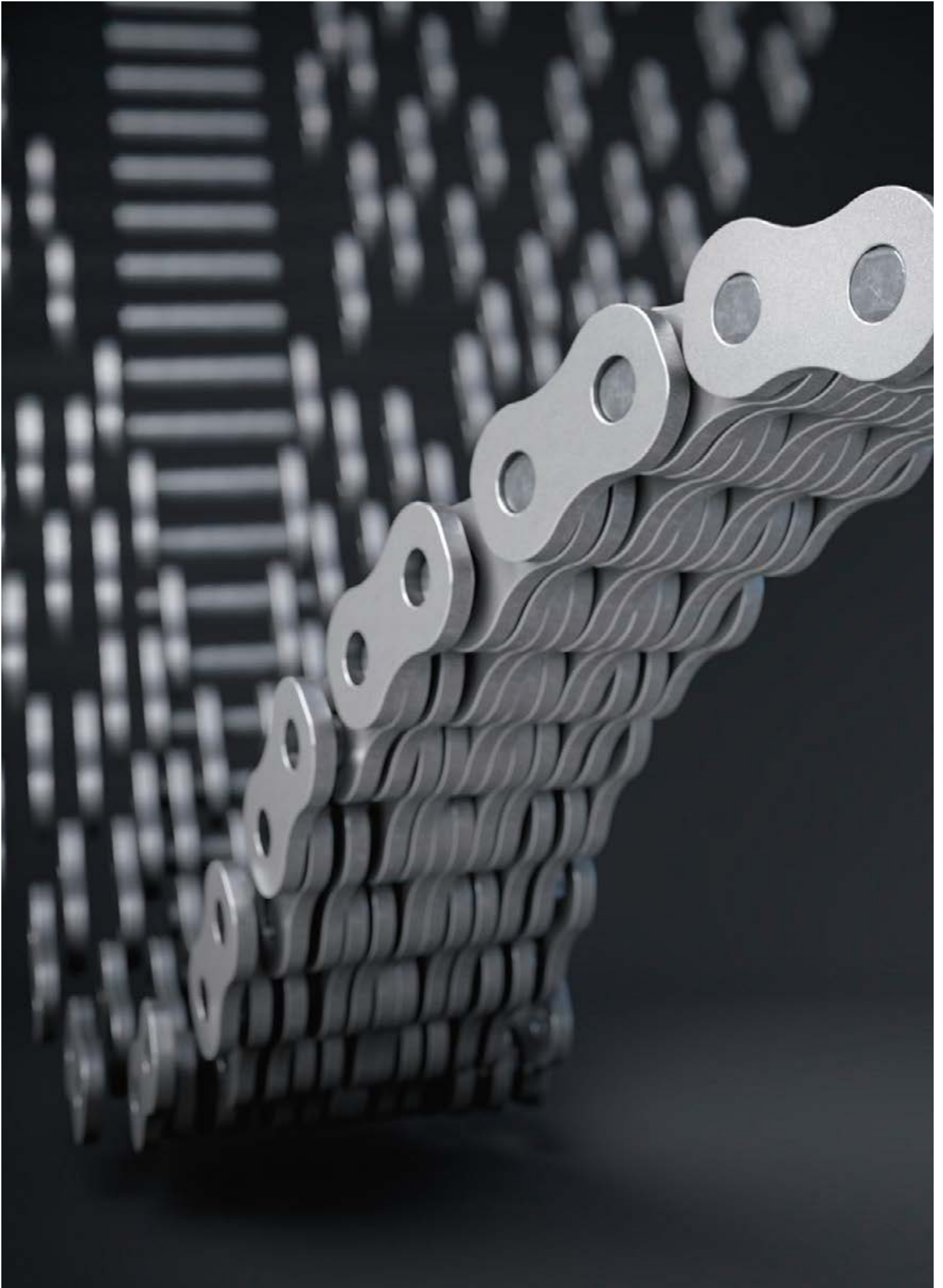

## Overview Rexnord chains

### Roller Chains

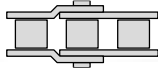

**REXNORD**

**RexPro**  
RexPro lubrication  
improved wear resistance  
high fatigue resistance

- Outstanding protection against corrosion and wear
- Unique protection against chain joint stiffness
- Extremely eco-friendly

**REXNORD**

**RexAthletic**  
good loading capacity  
extended lubrication intervals

- Durable and low-maintenance
- Longer servicing intervals
- High loading capacity

**REXNORD**

**RexCarbon**  
no lubrication  
low noise

- Maintenance-free
- Low noise
- Eco-friendly

**REXNORD**

**RexPlus**  
excellent corrosion resistance  
high reliability

- Excellent resistance to rust and acids
- Highly reliable
- Fulfills hygiene requirements
- NSF H1 certification

**REXNORD**

**RexPlusCarbon**  
no lubrication  
excellent corrosion resistance

- Combination of RexPlus and RexCarbon
- Excellent resistance to rust and acids
- Maintenance-free
- NSF H1 certification

**REXNORD**

**RexHiPro**  
good corrosion resistance  
excellent loading capacity

- Outstanding corrosion resistance
- Long service life
- High loading capacity

**Link-Belt**  
a brand of REXNORD

- The optimum choice for light and medium duty
- Good cost-benefit ratio
- High availability

**REXNORD**

**RexProX**  
RexPro lubrication  
improved wear resistance  
high fatigue resistance

- Extremely high loading capacity
- Long service life
- Outstanding protection against corrosion and wear

### Leaf Chains

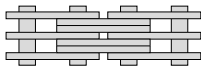

**REXNORD**

**RexPro**  
RexPro lubrication  
improved wear resistance  
high fatigue resistance

- Outstanding protection against corrosion and wear
- Unique protection against chain joint stiffness
- Extremely eco-friendly

**REXNORD**

**RexHiPro**  
good corrosion resistance  
excellent loading capacity

- Outstanding corrosion resistance
- Long service life
- High loading capacity

**REXNORD**

**RexAthletic**  
good loading capacity  
extended lubrication intervals

- Durable and low-maintenance
- Longer servicing intervals
- High loading capacity
- Extreme wear resistance for double-length service life

**REXDL**  
a brand of REXNORD

- The optimum choice for light and medium duty
- Good cost-benefit ratio
- Good availability





Extreme Performance from Rexnord

Leaf chains | RexHiPro

**REXNORD**

**RexHiPro**  
good corrosion resistance  
excellent loading capacity



RexHiPro

Extreme Performance from Rexnord.

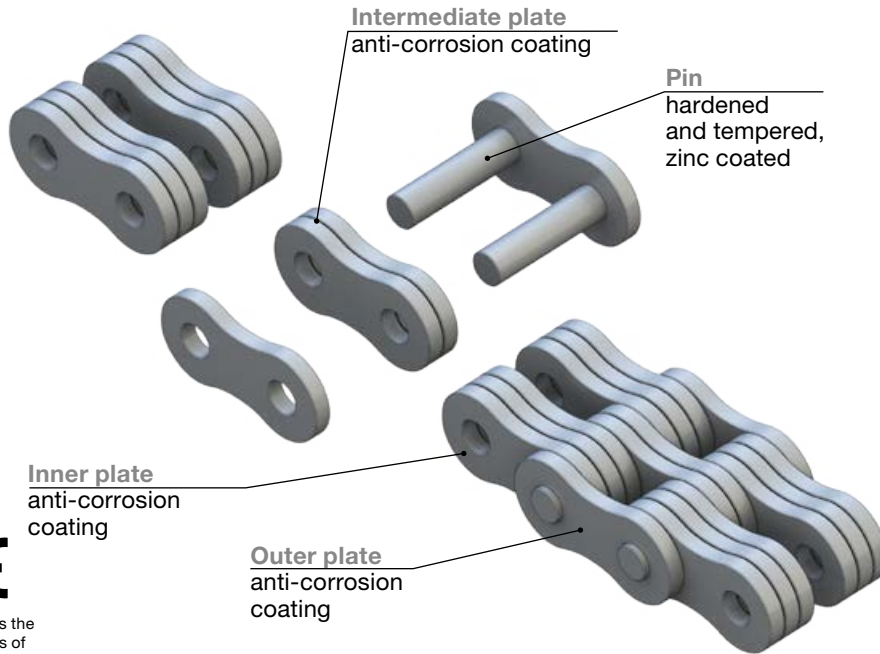

Rexnord fulfils the requirements of Machine Directive 2006/42/EC

APPLICATIONS

- Harbors & docks
- Industrial lifting equipment
- Outdoor applications
- Leisure parks

CHARACTERISTICS

- Anti-corrosion coating for all chain components
- Breaking strength and fatigue resistance as for RexPro chains
- Dimensions in accordance with DIN, ANSI and ISO standards
- No process-related hydrogen embrittlement
- No separate sprocket required
- Operating temperatures up to 250° C possible with high-temperature lubricants
- Does not contain chromium VI: conforms to Directive 2011/65/EC, RoHS and Directive 2000/53/EC

ADVANTAGES

- Excellent resistance to corrosion and wear
- Corrosion resistance for more than 600 hours (salt spray test in accordance with DIN EN ISO 9227)
- Resistant against liquids from the automotive industry in accordance with VDA 621-412

LUBRICATION

- Operating temperature: -30° C to +130° C
- RexPro lubricants used, contains no heavy metals: silicone and Teflon
- NSF H2 certification, RoHS:2005 conformity for the electrical and electronics industries

# RexHiPro - American type, Heavy series

Extreme Performance from Rexnord.



### Maintenance & Service lifespan

- High loading capacity, dynamic and static loads
- Material handling



### Applications & Characteristics

- Water, steam, aggressive liquids
- For extremely long, continuous service



### Eco-friendly

- NSF H2 certification
- RoHS:2005 conformity
- Free from chromium VI



Rexnord fulfils the requirements of Machine Directive 2006/42/EC

Table 1 of 2

RexHiPro leaf chains, DIN ISO 4347 (DIN 8152)

Chain No.	ISO chain number	Pitch		Lacing	Pin diameter		Plate depth	Thickness of plates	Length over 100 pitches.	Overall width	Bearing area	Width between outer plates	Required min. tensile strength ISO	Rexnord min. tensile strength	Fatigue strength	Weight
		p	p		d <sub>1</sub> max.	g max.										
		inch	mm		mm	mm										
BL 523	LH 1023	0.625	15.875	2 x 3	5.94	14.6	2.4	1596	15.0	0.43	7.4	33 400	40 000	10 500	1.1	
BL 534	LH 1034			3 x 4					20.0	0.57	12.3	48 900	60 000	11 500	1.5	
BL 544	LH 1044			4 x 4					22.5	0.57	14.7	66 700	80 000	12 000	1.8	
BL 546	LH 1046			4 x 6					27.3	0.86	19.5	66 700	80 000	14 000	2.2	
BL 566	LH 1066			6 x 6					32.3	0.86	24.6	100 100	120 000	15 200	2.6	
BL 588	LH 1088			8 x 8					42.2	1.14	34.3	133 600	160 000	17 000	3.4	
BL 622	LH 1222	0.75	19.05	2 x 2	7.92	17.9	3.1	1905	16.6	0.51	6.4	48 900	62 000	13 000	1.5	
BL 623	LH 1223			2 x 3					19.9	0.74	9.6	48 900	62 000	16 300	1.8	
BL 634	LH 1234			3 x 4					26.5	0.98	16.0	75 600	93 000	17 400	2.5	
BL 644	LH 1244			4 x 4					29.7	0.98	19.2	97 800	124 000	19 000	2.9	
BL 646	LH 1246			4 x 6					36.3	1.47	25.6	97 900	124 000	21 500	3.6	
BL 666	LH 1266			6 x 6					42.7	1.47	32.0*	146 800	186 000	24 500	4.3	
BL 822	LH 1622	1.00	25.4	2 x 2	9.53	23.6	4.0	2540	20.6	0.76	8.2	84 500	110 000	22 000	2.4	
BL 823	LH 1623			2 x 3					24.8	1.14	12.3	84 500	110 000	30 000	3.0	
BL 834	LH 1634			3 x 4					33.1	1.53	20.5	129 800	165 000	32 000	4.2	
BL 844	LH 1644			4 x 4					37.3	1.53	24.6	169 000	220 000	33 500	4.8	
BL 846	LH 1646			4 x 6					45.6	2.29	32.9	169 000	220 000	38 500	6.0	
BL 866	LH 1666			6 x 6					54.1	2.29	41.3	253 600	330 000	42 000	7.2	
BL 888	LH 1688	8 x 8	70.8	3.05	57.9	338 000	440 000	45 000	9.6							
BL 1023	LH 2023	1.25	31.75	2 x 3	11.10	29.2	4.7	3179	28.9	1.57	14.4	115 600	164 000	47 500	4.4	
BL 1034	LH 2034			3 x 4					38.7	2.09	24.1	182 400	246 000	50 000	6.2	
BL 1044	LH 2044			4 x 4					43.6	2.09	29.0	231 200	328 000	55 000	7.0	
BL 1046	LH 2046			4 x 6					53.6	3.13	38.9*	231 200	328 000	62 000	8.7	
BL 1066	LH 2066			6 x 6					63.4	3.13	48.6*	347 000	492 000	69 000	10.5	
BL 1088	LH 2088			8 x 8					83.1	4.18	68.2	462 400	656 000	74 000	13.9	

MODULE\_08/GB/2014/08 // No liability accepted for misprints or errors!

\* Please contact us regarding precision of fit with ISO anchors

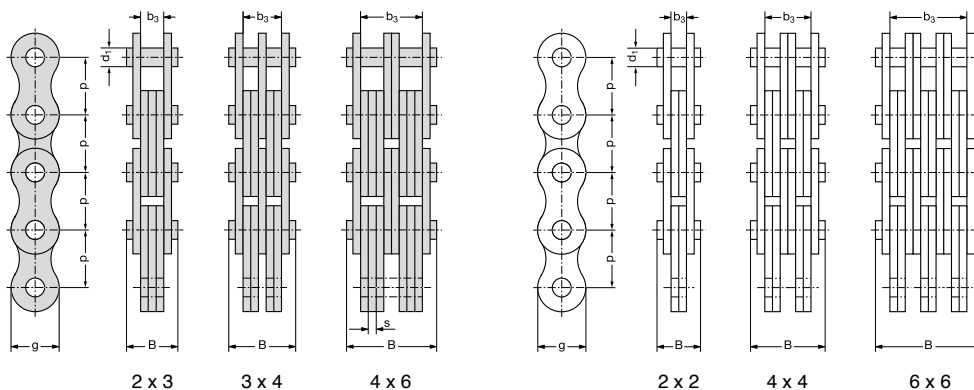

## RexHiPro - American type, Heavy series

Extreme Performance from Rexnord.



### Maintenance & Service lifespan

- High loading capacity, dynamic and static loads
- Material handling



### Applications & Characteristics

- Water, steam, aggressive liquids
- For extremely long, continuous service



Rexnord fulfils the requirements of Machine Directive 2006/42/EC



### Eco-friendly

- NSF H2 certification
- RoHS:2005 conformity
- Free from chromium VI

Table 2 of 2

RexHiPro leaf chains, DIN ISO 4347 (DIN 8152)

Chain No.	ISO chain number	Pitch		Lacing	Pin diameter				Plate depth	Thickness of plates	Length over 100 pitches.	Overall width			Bearing area	Width between outer plates	Required min. tensile strength ISO	Rexnord min. tensile strength	Fatigue strength	Weight
		p	mm		d <sub>1</sub> max.	g max.	s	■				B max.	A	b <sub>3</sub> min.						
BL 1223	LH 2423	1.5	38.10	2 x 3	12.7	34.4	5.5	3810				33.6	2.10	16.8	151 200	200 000	64 000	6.0		
BL 1234	LH 2434			3 x 4								45.5	2.80	28.0	244 600	300 000	68 000	8.3		
BL 1244	LH 2444			4 x 4								51.2	2.80	33.6	302 400	400 000	72 000	9.5		
BL 1246	LH 2446			4 x 6								62.7	4.20	44.8	302 400	400 000	82 500	11.8		
BL 1266	LH 2466			6 x 6								74.5	4.20	56.0*	453 600	600 000	90 000	14.1		
BL 1288	LH 2488			8 x 8								97.8	5.40	78.4	604 800	800 000	98 000	18.8		
BL 1423	LH 2823	1.75	44.45	2 x 3	14.27	40.8	6.3	4445				38.2	2.70	19.2	191 300	250 000		8.3		
BL 1434	LH 2834			3 x 4								51.7	3.60	32.0	315 800	375 000		11.6		
BL 1444	LH 2844			4 x 4								58.2	3.60	38.4	382 600	500 000		13.2		
BL 1446	LH 2846			4 x 6								71.5	5.40	51.2	382 600	500 000		16.4		
BL 1466	LH 2866			6 x 6								85.0	5.40	64.0*	578 300	750 000		19.7		
BL 1488	LH 2888			8 x 8								111.7	7.20	89.6	765 200	1 000 000		25.9		
BL 1623	LH 3223	2.00	50.8	2 x 3	17.46	47.9	7.0	5080				42.1	3.67	21.3*	289 100	360 000		11.0		
BL 1634	LH 3234			3 x 4								57.0	4.89	35.5*	440 400	540 000		15.4		
BL 1644	LH 3244			4 x 4								63.8	5.00	42.6*	578 200	720 000		17.5		
BL 1646	LH 3246			4 x 6								78.9	7.33	56.8*	578 200	720 000		21.8		
BL 1666	LH 3266			6 x 6								95.0	7.33	73.7*	867 400	1 080 000		26.2		
BL 1688	LH 3288			8 x 8								125.6	9.78	103.5	1 156 400	1 440 000		34.9		

\* Please contact us regarding precision of fit with ISO anchors.

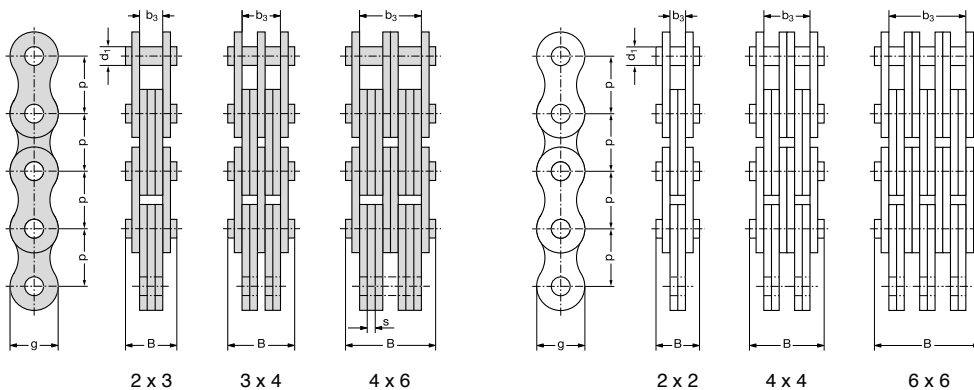

### Recommended chain anchor dimensions for connecting leaf chain inner links

Chain No.	Inner link connector dimensions Dimensions in mm									
	f	b	c	d <sub>1</sub>	e	r <sub>1</sub>	r <sub>2</sub>			
	max.	min.	max.	D 10	min.	max.	max.			
BL 522	12.7	5.0	–	6.0	11.0	8.0	2.0			
BL 523	14.9	7.5	–				2.0			
BL 534	19.9	5.0	2.4				2.0			
BL 544	22.4	5.0	4.8				2.0			
BL 546	26.9	7.5	4.8				2.0			
BL 566	31.9	5.0	4.8				2.0			
BL 588	42.4	5.0	4.8				2.0			
BL 623	19.9	10.3	–				8.0	14.0	9.5	5.0
BL 634	26.9	6.8	3.2	3.0						
BL 644	29.9	6.8	6.4	3.0						
BL 646	36.9	10.3	6.4	3.0						
BL 666	42.9	6.8	6.4	3.0						
BL 688	56.4	6.8	6.4	3.0						
BL 823	24.9	12.8	–	9.6	18.0	12.5				6.0
BL 834	32.9	8.5	4.0							4.0
BL 844	36.9	8.5	8.0				4.0			
BL 846	45.9	12.8	8.0				6.0			
BL 866	52.9	8.5	8.0				4.0			
BL 888	69.4	8.5	8.0				4.0			
BL 1023	69.4	15.1	8.0				11.2	22.0	15.0	4.0
BL 1034	39.0	10.0	4.7							5.0
BL 1044	44.0	10.0	9.4	5.0						
BL 1046	54.0	15.1	9.4	7.0						
BL 1066	63.0	10.0	9.4	5.0						
BL 1088	79.7	10.0	9.4	5.0						
BL 1223	34.3	17.7	–	12.8	26.0	19.0				8.0
BL 1234	46.0	11.8	5.5							5.0
BL 1244	51.7	11.8	11.0				5.0			
BL 1246	63.3	17.7	11.0				8.0			
BL 1266	75.1	11.8	11.0				5.0			
BL 1288	98.4	11.8	11.0				5.0			
BL 1423	38.5	20.1	–				14.3	31.0	22.0	10.0
BL 1434	52.0	13.4	6.3							6.0
BL 1444	58.4	13.4	12.6	6.0						
BL 1446	71.5	20.1	12.6	10.0						
BL 1466	84.9	13.4	12.6	6.0						
BL 1623	42.8	22.5	–	17.5	34.0	25.0				10.0
BL 1634	57.7	15.0	7.1							7.0
BL 1644	65.4	15.0	14.2							7.0
BL 1646	79.6	22.5	14.2				10.0			
BL 1666	94.3	15.0	14.2				7.0			
BL 1688	123.7	15.0	14.2				7.0			

### Connecting pin for joining leaf chains to chain anchor

Chain No.	Connecting pin order no.	Connecting pin Dimensions in mm					
		l min.	L max.	d max.	d <sub>2</sub>		
		BL 522	709 – 355 – 22	12.8	19.4	5.94	2.0
BL 523	709 – 355 – 23	15.0	21.6				
BL 534	709 – 355 – 34	20.0	26.6				
BL 544	709 – 355 – 44	22.5	29.1				
BL 546	709 – 355 – 46	27.0	33.7				
BL 566	709 – 355 – 66	32.0	38.7				
BL 588	709 – 355 – 88	42.5	49.3				
BL 623	709 – 307 – 23	20.0	30.7	7.92	3.2		
BL 634	709 – 307 – 34	27.0	37.7				
BL 644	709 – 307 – 44	30.0	40.7				
BL 646	709 – 307 – 46	37.0	47.7				
BL 666	709 – 307 – 66	43.0	53.7				
BL 688	709 – 307 – 88	56.5	67.2				
BL 823	709 – 309 – 23	25.0	35.7			9.53	3.2
BL 834	709 – 309 – 34	33.0	43.7				
BL 844	709 – 309 – 44	37.0	47.7				
BL 846	709 – 309 – 46	46.0	56.7				
BL 866	709 – 309 – 66	53.0	63.7				
BL 888	709 – 309 – 88	69.5	80.3				
BL 1023	709 – 311 – 23	30.0	42.4	11.1	4.0		
BL 1034	709 – 311 – 34	39.2	51.6				
BL 1044	709 – 311 – 44	44.2	56.6				
BL 1046	709 – 311 – 46	54.2	66.6				
BL 1066	709 – 311 – 66	63.2	75.6				
BL 1088	709 – 311 – 88	79.9	92.4				
BL 1223	709 – 312 – 23	34.5	46.9			12.7	4.0
BL 1234	709 – 312 – 34	46.2	58.6				
BL 1244	709 – 312 – 44	51.9	64.4				
BL 1246	709 – 312 – 46	63.5	76.0				
BL 1266	709 – 312 – 66	75.3	87.8				
BL 1288	709 – 312 – 88	98.6	111.1				
BL 1423	709 – 314 – 23	38.7	51.1	14.27	4.0		
BL 1434	709 – 314 – 34	52.2	64.6				
BL 1444	709 – 314 – 44	58.6	71.1				
BL 1446	709 – 314 – 46	71.7	84.2				
BL 1466	709 – 314 – 66	85.1	97.7				
BL 1623	709 – 317 – 23	43.1	60.6			17.46	5.0
BL 1634	709 – 317 – 34	58.0	75.5				
BL 1644	709 – 317 – 44	65.7	82.9				
BL 1646	709 – 317 – 46	79.9	97.4				
BL 1666	709 – 317 – 66	94.6	112.2				
BL 1688	709 – 317 – 88	124.0	141.6				

MODULE\_08/GB/2014/08 // No liability accepted for misprints or errors!

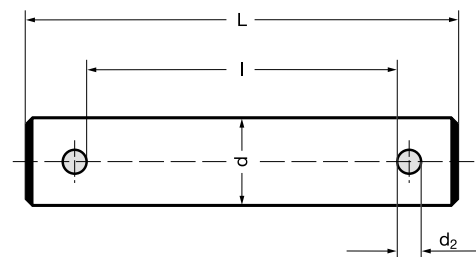
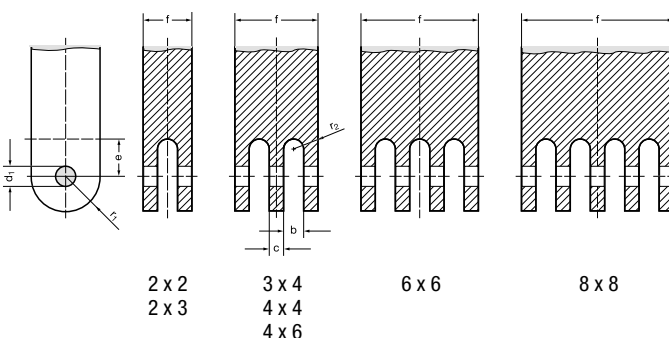

All pins are fitted with 2 cotters and – from BL 1234 and F 38 upwards – with 2 additional washers.

## Overview Rexnord chains

### Roller Chains

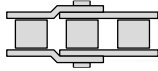

**REXNORD**

**RexPro**  
RexPro lubrication  
improved wear resistance  
high fatigue resistance

- Outstanding protection against corrosion and wear
- Unique protection against chain joint stiffness
- Extremely eco-friendly

**REXNORD**

**RexAthletic**  
good loading capacity  
extended lubrication intervals

- Durable and low-maintenance
- Longer servicing intervals
- High loading capacity

**REXNORD**

**RexCarbon**  
no lubrication  
low noise

- Maintenance-free
- Low noise
- Eco-friendly

**REXNORD**

**RexPlus**  
excellent corrosion resistance  
high reliability

- Excellent resistance to rust and acids
- Highly reliable
- Fulfills hygiene requirements
- NSF H1 certification

**REXNORD**

**RexPlusCarbon**  
no lubrication  
excellent corrosion resistance

- Combination of RexPlus and RexCarbon
- Excellent resistance to rust and acids
- Maintenance-free
- NSF H1 certification

**REXNORD**

**RexHiPro**  
good corrosion resistance  
excellent loading capacity

- Outstanding corrosion resistance
- Long service life
- High loading capacity

**Link-Belt**  
a brand of REXNORD

- The optimum choice for light and medium duty
- Good cost-benefit ratio
- High availability

**REXNORD**

**RexProX**  
RexPro lubrication  
improved wear resistance  
high fatigue resistance

- Extremely high loading capacity
- Long service life
- Outstanding protection against corrosion and wear

### Leaf Chains

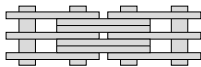

**REXNORD**

**RexPro**  
RexPro lubrication  
improved wear resistance  
high fatigue resistance

- Outstanding protection against corrosion and wear
- Unique protection against chain joint stiffness
- Extremely eco-friendly

**REXNORD**

**RexHiPro**  
good corrosion resistance  
excellent loading capacity

- Outstanding corrosion resistance
- Long service life
- High loading capacity

**REXNORD**

**RexAthletic**  
good loading capacity  
extended lubrication intervals

- Durable and low-maintenance
- Longer servicing intervals
- High loading capacity
- Extreme wear resistance for double-length service life

**REXDL**  
a brand of REXNORD

- The optimum choice for light and medium duty
- Good cost-benefit ratio
- Good availability