



Approved Performance from Rexnord

Roller chains | European type

Link-Belt®
a brand of
REXNORD



Roller chains - European type

Approved Performance from Rexnord.

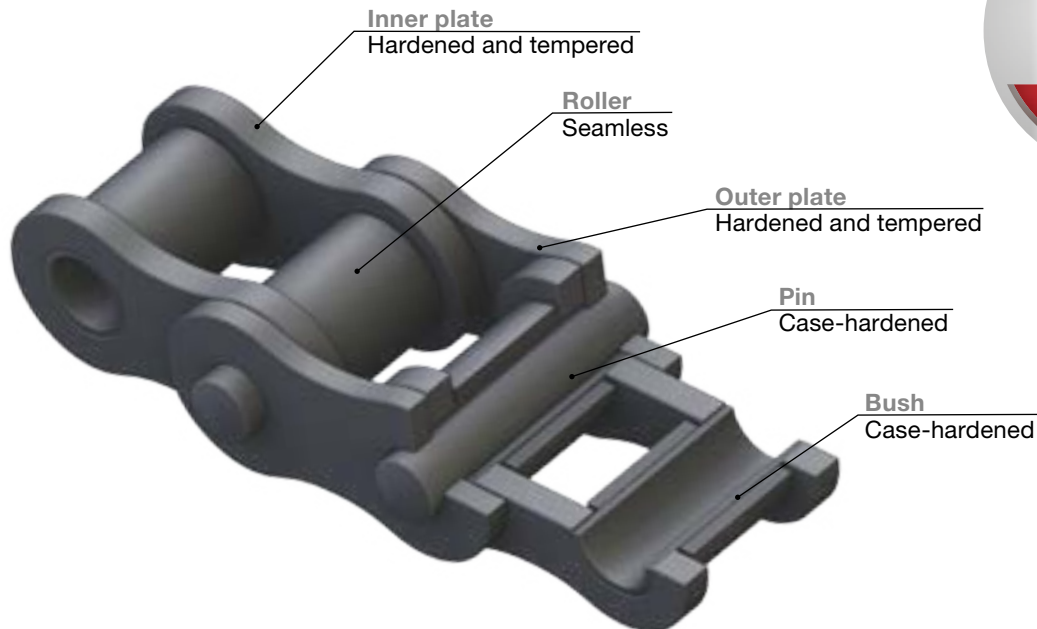

APPLICATIONS

- Light and medium duty
- Agricultural machinery, wood processing
- Textile industry

CHARACTERISTICS

- Established brand name
- Fulfils ISO quality requirements
- Rexnord guarantees the achievement of performance requirements

ADVANTAGES

- Good cost-benefit ratio
- Good availability
- Robust quality

LUBRICATION

- Contains no heavy metals
- Fulfils REACH requirements

Roller chains - European type

Approved Performance from Rexnord.

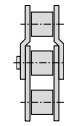

Simplex roller chains



Proven performance

- Fulfills ISO quality requirements
- Rexnord guarantees the achievement of performance requirements
- Optimum choice for light and medium duty



Purchasing policy

- Suppliers must comply with local environmental laws
- Suppliers must comply with Rexnord's ethical policy and internal guidelines
- Suppliers must take local environmental policy into account



Economical

- Good cost-benefit ratio
- Good availability



Simplex roller chains, ISO 606

Chain No.	Pitch		Width between inner plates	Roller diameter	Pin diameter	Width over inner link	Plate depth	Transverse pitch	Pin length	Connecting pin length	Bearing area	Required min. tensile strength DIN / ISO	Weight	Loose parts							
	p	p												b ₁ min.	d ₁ max.	d ₂ max.	b ₂ max.	g max.	e	a ₁ max.	a ₃ max.
	inch	mm	mm	mm	mm	mm	mm	mm	mm	mm	mm	cm ²	N	kg/m							
04 B-1	0.235	6.0	2.80	4.00	1.85	4.10	5.0	-	7.4	10.3	0.08	3 000	0.1			x	x				
05 B-1	0.315	8.0	3.00	5.00	2.31	4.77	7.1	-	8.6	11.7	0.11	4 400	0.2			x	x				
06 B-1	0.375	9.525	5.72	6.35	3.28	8.53	8.2	-	13.5	16.8	0.28	8 900	0.4			x	x	x			
08 B-1	0.50	12.7	7.75	8.51	4.45	11.30	11.8	-	17.0	20.9	0.50	17 800	0.7			x	x	x			
10 B-1	0.625	15.875	9.65	10.16	5.08	13.28	14.7	-	19.6	23.7	0.67	22 200	0.9			x	x	x	x		
12 B-1	0.75	19.05	11.68	12.07	5.72	15.62	16.2	-	22.7	27.3	0.89	28 900	1.2			x	x	x	x		
16 B-1	1.00	25.4	17.02	15.88	8.28	25.45	21.0	-	36.1	41.5	2.11	60 000	2.7			x	x	x	x		
20 B-1	1.25	31.75	19.56	19.05	10.19	29.01	26.4	-	43.2	49.3	2.96	95 000	3.6						x	x	
24 B-1	1.50	38.1	25.40	25.40	14.63	37.92	33.4	-	53.4	60.0	5.55	160 000	6.7						x	x	
28 B-1	1.75	44.45	30.99	27.97	15.80	46.58	37.0	-	65.1	72.5	7.36	200 000	8.7						x	x	
32 B-1	2.00	50.8	30.99	29.21	17.81	45.57	42.2	-	67.4	75.3	8.12	250 000	10.0						x	x	

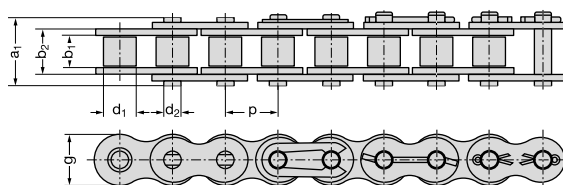

B inner link A outer link E connecting link with clip S connecting link with cotter L cranked link with cotter C double cranked link

Roller chains - European type

Approved Performance from Rexnord.

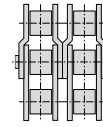

Duplex roller chains



Proven performance

- Fulfills ISO quality requirements
- Rexnord guarantees the achievement of performance requirements
- Optimum choice for light and medium duty



Purchasing policy

- Suppliers must comply with local environmental laws
- Suppliers must comply with Rexnord's ethical policy and internal guidelines
- Suppliers must take local environmental policy into account



Economical

- Good cost-benefit ratio
- Good availability

Duplex roller chains, ISO 606

Chain No.	Pitch		Width between inner plates	Roller diameter	Pin diameter	Width over inner link	Plate depth	Transverse pitch	Pin length	Connecting pin length	Bearing area	Required min. tensile strength DIN / ISO	Weight	Loose parts							
	p	p												b ₁ min.	d ₁ max.	d ₂ max.	b ₂ max.	g max.	e	a ₁ max.	a ₃ max.
	inch	mm	mm	mm	mm	mm	mm	mm	mm	mm	mm	cm ²	N	kg/m							
06 B-2	0.375	9.525	5.72	6.35	3.28	8.53	8.2	10.24	23.8	27.1	0.56	19 600	0.8			x	x	x			
08 B-2	0.50	12.7	7.75	8.51	4.45	11.30	11.8	13.92	31.0	34.9	1.01	31 100	1.4			x	x	x			
10 B-2	0.625	15.875	9.65	10.16	5.08	13.28	14.7	16.59	36.2	40.3	1.35	44 500	1.8			x	x	x	x		
12 B-2	0.75	19.05	11.68	12.07	5.72	15.62	16.2	19.46	42.2	46.8	1.79	57 800	2.3			x	x	x	x		
16 B-2	1.00	25.4	17.02	15.88	8.28	25.45	21.0	31.88	68.0	73.4	4.21	106 000	5.3			x	x	x	x		
20 B-2	1.25	31.75	19.56	19.05	10.19	29.01	26.4	36.45	79.7	85.8	5.91	170 000	7.0						x	x	
24 B-2	1.50	38.1	25.40	25.40	14.63	37.92	33.4	48.36	101.8	108.4	11.10	280 000	13.2						x	x	
28 B-2	1.75	44.45	30.99	27.97	15.80	46.58	37.0	59.56	124.7	132.1	14.72	360 000	17.5						x	x	
32 B-2	2.00	50.8	30.99	29.21	17.81	45.57	42.2	58.55	126.0	133.9	16.23	450 000	19.5						x	x	

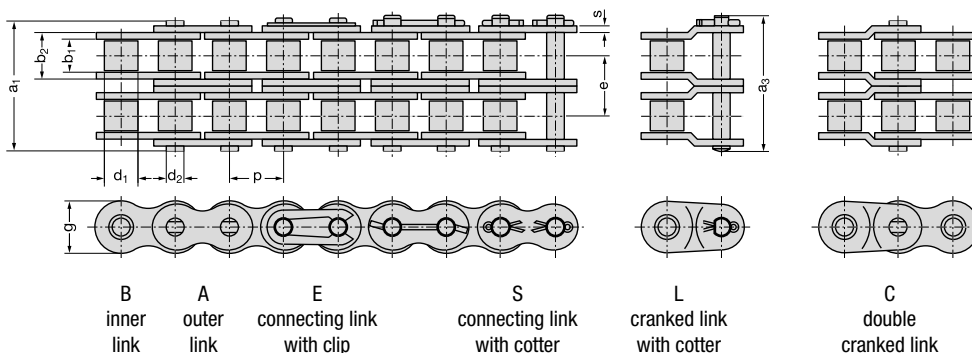

Roller chains - European type

Approved Performance from Rexnord.

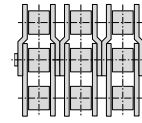

Triplex roller chains



Proven performance

- Fulfills ISO quality requirements
- Rexnord guarantees the achievement of performance requirements
- Optimum choice for light and medium duty



Purchasing policy

- Suppliers must comply with local environmental laws
- Suppliers must comply with Rexnord's ethical policy and internal guidelines
- Suppliers must take local environmental policy into account



Economical

- Good cost-benefit ratio
- Good availability



Triplex roller chains, ISO 606

Chain No.	Pitch		Width between inner plates	Roller diameter	Pin diameter	Width over inner link	Plate depth	Transverse pitch	Pin length	Connecting pin length	Bearing area	Required min. tensile strength DIN/ISO	Weight	Loose parts							
	p													b ₁ min.	d ₁ max.	d ₂ max.	b ₂ max.	g max.	e	a ₁ max.	a ₃ max.
	inch	mm	mm	mm	mm	mm	mm	mm	mm	mm	mm	cm ²	N	kg/m							
06 B-3	0.375	9.525	5.72	6.35	3.28	8.53	8.2	10.24	34.0	37.3	0.84	24 900	1.2			x	x	x			
08 B-3	0.50	12.7	7.75	8.51	4.45	11.30	11.8	13.92	44.9	48.8	1.51	44 500	2.1			x	x	x			
10 B-3	0.625	15.875	9.65	10.16	5.08	13.28	14.7	16.59	52.8	56.9	2.02	66 700	2.7			x	x	x	x		
12 B-3	0.75	19.05	11.68	12.07	5.72	15.62	16.2	19.46	61.7	66.3	2.68	86 700	3.4			x	x	x	x		
16 B-3	1.00	25.4	17.02	15.88	8.28	25.45	21.0	31.88	99.9	105.3	6.32	160 000	7.9			x	x	x	x		
20 B-3	1.25	31.75	19.56	19.05	10.19	29.01	26.4	36.45	116.1	122.2	8.87	250 000	10.4						x	x	
24 B-3	1.50	38.1	25.40	25.40	14.63	37.90	33.4	48.36	150.2	156.8	16.64	425 000	19.7							x	x
28 B-3	1.75	44.45	30.99	27.97	15.80	46.58	37.0	59.56	184.3	191.7	22.08	530 000	26.1							x	x
32 B-3	2.00	50.8	30.99	29.21	17.81	45.57	42.2	58.55	184.5	192.4	24.35	670 000	29.0							x	x

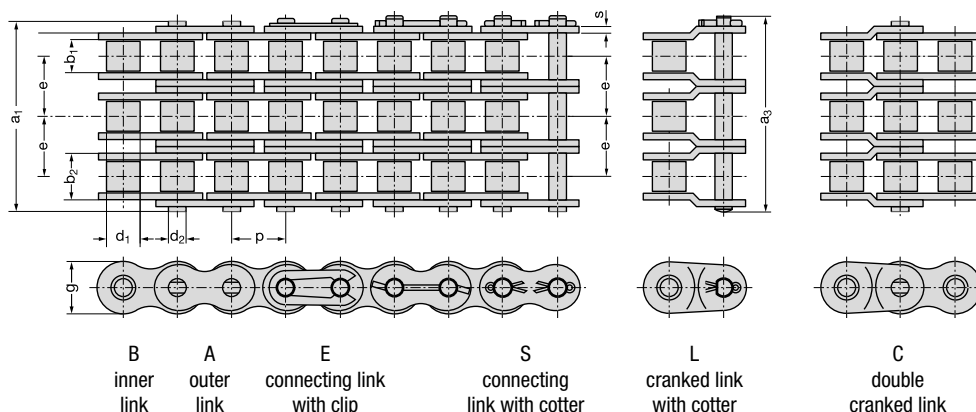

MODULE_05/GB/2014/08 // No liability accepted for misprints or errors!

Overview Rexnord roller chains

Roller Chains

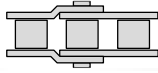

REXNORD

RexPro
RexPro lubrication
improved wear resistance
high fatigue resistance

- Outstanding protection against corrosion and wear
- Unique protection against chain joint stiffness
- Extremely eco-friendly

REXNORD

RexAthletic
good loading capacity
extended lubrication intervals

- Durable and low-maintenance
- Longer servicing intervals
- High loading capacity

REXNORD

RexCarbon
no lubrication
low noise

- Maintenance-free
- Low noise
- Eco-friendly

REXNORD

RexPlus
excellent corrosion resistance
high reliability

- Excellent resistance to rust and acids
- Highly reliable
- Fulfills hygiene requirements
- NSF H1 certification

REXNORD

RexPlusCarbon
no lubrication
excellent corrosion resistance

- Combination of RexPlus and RexCarbon
- Excellent resistance to rust and acids
- Maintenance-free
- NSF H1 certification

REXNORD

RexHiPro
good corrosion resistance
excellent loading capacity

- Outstanding corrosion resistance
- Long service life
- High loading capacity

Link-Belt
a brand of REXNORD

- The optimum choice for light and medium duty
- Good cost-benefit ratio
- High availability

REXNORD

RexProX
RexPro lubrication
improved wear resistance
high fatigue resistance

- Extremely high loading capacity
- Long service life
- Outstanding protection against corrosion and wear

Leaf Chains

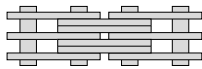

REXNORD

RexPro
RexPro lubrication
improved wear resistance
high fatigue resistance

- Outstanding protection against corrosion and wear
- Unique protection against chain joint stiffness
- Extremely eco-friendly

REXNORD

RexHiPro
good corrosion resistance
excellent loading capacity

- Outstanding corrosion resistance
- Long service life
- High loading capacity

REXNORD

RexAthletic
good loading capacity
extended lubrication intervals

- Durable and low-maintenance
- Longer servicing intervals
- High loading capacity
- Extreme wear resistance for double-length service life

REXDL
a brand of REXNORD

- The optimum choice for light and medium duty
- Good cost-benefit ratio
- Good availability



Approved Performance from Rexnord

Roller chains | American type



Roller chains - American type

Approved Performance from Rexnord.

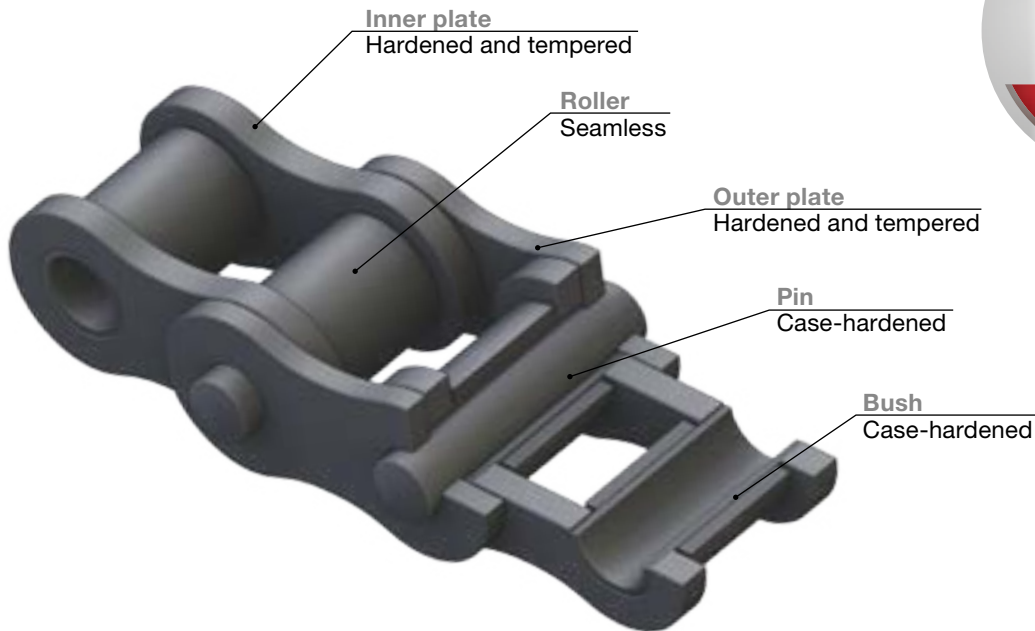

APPLICATIONS

- Light and medium duty
- Agricultural machinery, wood processing
- Textile industry

CHARACTERISTICS

- Established brand name
- Fulfils ISO quality requirements
- Rexnord guarantees the achievement of performance requirements

ADVANTAGES

- Good cost-benefit ratio
- Good availability
- Robust quality

LUBRICATION

- Contains no heavy metals
- Fulfils REACH requirements

Roller chains - American type

Approved Performance from Rexnord.

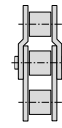

Simplex roller chains



Proven performance

- Fulfills ISO quality requirements
- Rexnord guarantees the achievement of performance requirements
- Optimum choice for light and medium duty



Purchasing policy

- Suppliers must comply with local environmental laws
- Suppliers must comply with Rexnord's ethical policy and internal guidelines
- Suppliers must take local environmental policy into account



Economical

- Good cost-benefit ratio
- Good availability



Simplex roller chains, ISO 606

Chain No.	Pitch		Width between inner plates		Roller diameter	Pin diameter	Width over inner link	Plate depth	Transverse pitch	Pin length	Connecting pin length	Bearing area	Required min. tensile strength DIN/ISO	Weight	Loose parts					
	p	inch	mm	b ₁ min.	d ₁ max.	d ₂ max.	b ₂ max.	g max.	e	a ₁ max.	a ₃ max.	A	F _u	q	A	B	C	E	L	S
															mm	mm	mm	mm	mm	mm
40-1	0.50	12.7	7.85	7.92	3.96	11.17	12.0	-	17.8	21.7	0.44	13 900	0.6			x	x	x		
50-1	0.625	15.875	9.40	10.16	5.08	13.84	15.0	-	21.8	25.9	0.70	21 800	1.0			x	x	x		
60-1	0.75	19.05	12.57	11.91	5.94	17.75	18.1	-	26.9	31.5	1.05	31 300	1.5			x	x	x	x	
80-1	1.00	25.4	15.75	15.88	7.92	22.60	24.1	-	33.5	38.9	1.79	55 600	2.6			x	x	x	x	
100-1	1.25	31.75	18.90	19.05	9.53	27.45	30.1	-	41.1	47.2	2.62	87 000	4.0					x	x	
120-1	1.50	38.1	25.22	22.23	11.10	35.45	36.2	-	50.8	57.4	3.93	125 000	5.5					x	x	
140-1	1.75	44.45	25.22	25.40	12.70	37.18	42.2	-	54.9	62.3	4.72	170 000	7.5					x	x	
160-1	2.00	50.8	31.55	28.58	14.27	45.21	48.2	-	65.5	73.4	6.45	223 000	10.2					x	x	

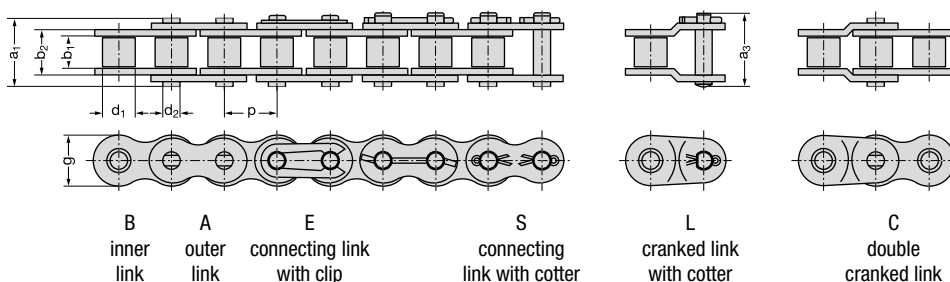

Roller chains - American type

Approved Performance from Rexnord.

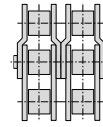

Duplex roller chains



Proven performance

- Fulfills ISO quality requirements
- Rexnord guarantees the achievement of performance requirements
- Optimum choice for light and medium duty



Purchasing policy

- Suppliers must comply with local environmental laws
- Suppliers must comply with Rexnord's ethical policy and internal guidelines
- Suppliers must take local environmental policy into account



Economical

- Good cost-benefit ratio
- Good availability

Duplex roller chains, ISO 606

Chain No.	Pitch		Width between inner plates	Roller diameter	Pin diameter	Width over inner link	Plate depth	Transverse pitch	Pin length	Connecting pin length	Bearing area	Required min. tensile strength DIN/ISO	Weight	Loose parts							
	p													b ₁ min.	d ₁ max.	d ₂ max.	b ₂ max.	g max.	e	a ₁ max.	a ₃ max.
	inch	mm	mm	mm	mm	mm	mm	mm	mm	mm	mm	cm ²	N	kg/m							
40-2	0.50	12.7	7.85	7.92	3.96	11.17	12.0	14.38	32.3	36.2	0.88	27 800	1.2			x	x	x			
50-2	0.625	15.875	9.40	10.16	5.08	13.84	15.0	18.11	39.9	44.0	1.41	43 600	2.0			x	x	x			
60-2	0.75	19.05	12.57	11.91	5.94	17.75	18.1	22.78	49.8	54.4	2.11	62 600	3.0			x	x	x	x		
80-2	1.00	25.4	15.75	15.88	7.92	22.60	24.1	29.29	62.7	68.1	3.58	111 200	5.2			x	x	x	x		
100-2	1.25	31.75	18.90	19.05	9.53	27.45	30.1	35.76	77.0	83.1	5.23	174 000	8.0					x	x		
120-2	1.50	38.1	25.22	22.23	11.10	35.45	36.2	45.44	96.3	102.9	7.87	250 000	11.0					x	x		
140-2	1.75	44.45	25.22	25.40	12.70	37.18	42.2	48.87	103.6	111.0	9.44	340 000	14.9					x	x		
160-2	2.00	50.8	31.55	28.58	14.27	45.21	48.2	58.55	124.2	132.1	12.90	446 000	20.2					x	x		

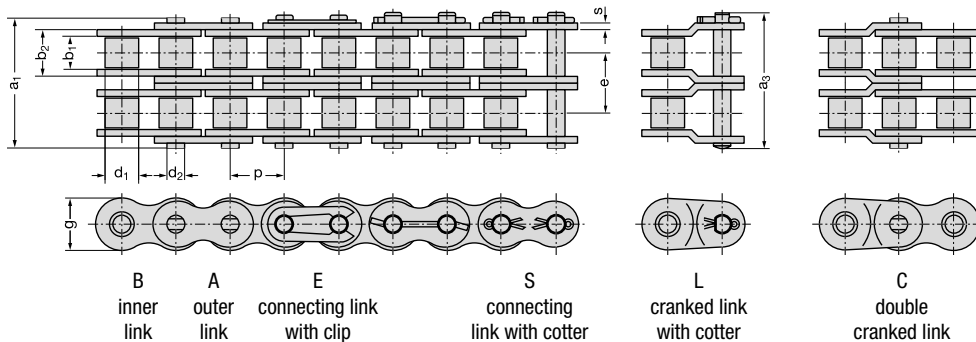

Roller chains - American type

Approved Performance from Rexnord.

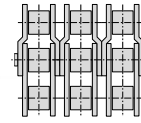

Triplex roller chains



Proven performance

- Fulfills ISO quality requirements
- Rexnord guarantees the achievement of performance requirements
- Optimum choice for light and medium duty



Purchasing policy

- Suppliers must comply with local environmental laws
- Suppliers must comply with Rexnord's ethical policy and internal guidelines
- Suppliers must take local environmental policy into account



Economical

- Good cost-benefit ratio
- Good availability



Triplex roller chains, ISO 606

Chain No.	Pitch		Width between inner plates	Roller diameter	Pin diameter	Width over inner link	Plate depth	Transverse pitch	Pin length	Connecting pin length	Bearing area	Required min. tensile strength DIN/ISO	Weight	Loose parts							
	p	p												b ₁ min.	d ₁ max.	d ₂ max.	b ₂ max.	g max.	e	a ₁ max.	a ₃ max.
	inch	mm	mm	mm	mm	mm	mm	mm	mm	mm	mm	cm ²	N	kg/m							
40-3	0.50	12.7	7.85	7.92	3.96	11.17	12.0	14.48	46.7	50.6	1.33	41 700	1.8			x	x	x			
50-3	0.625	15.875	9.40	10.16	5.08	13.84	15.0	18.11	57.9	62.0	2.11	65 400	3.0			x	x	x			
60-3	0.75	19.05	12.57	11.91	5.94	17.75	18.1	22.78	72.6	77.2	3.16	93 900	4.5			x	x	x	x		
80-3	1.00	25.4	15.75	15.88	7.92	22.60	24.1	29.29	91.9	97.3	5.37	166 800	7.8			x	x	x	x		
100-3	1.25	31.75	18.90	19.05	9.53	27.45	30.1	35.76	113.0	119.1	7.85	261 000	12.0					x	x		
120-3	1.50	38.1	25.22	22.23	11.10	35.45	36.2	45.44	141.7	148.3	11.80	375 000	16.5					x	x		
140-3	1.75	44.45	25.22	25.40	12.70	37.18	42.2	48.87	152.4	159.8	14.17	510 000	22.4					x	x		
160-3	2.00	50.8	31.55	28.58	14.27	45.21	48.2	58.55	182.9	190.8	19.35	669 000	30.4					x	x		

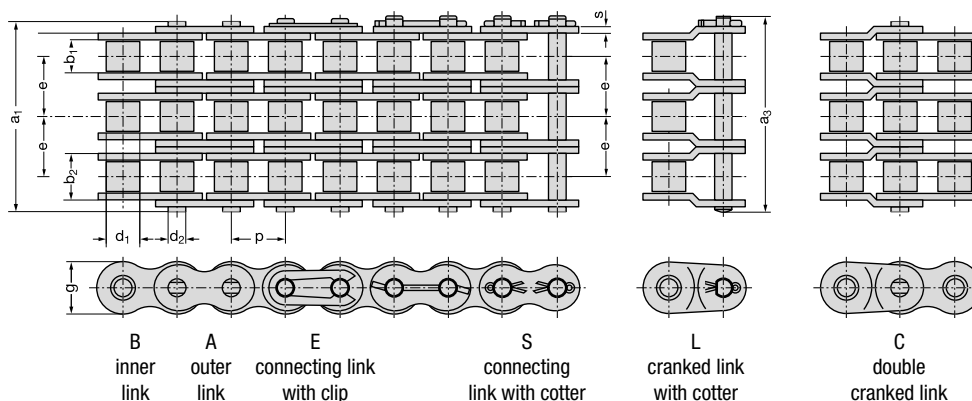

Overview Rexnord roller chains

Roller Chains

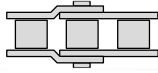

REXNORD

RexPro
RexPro lubrication
improved wear resistance
high fatigue resistance

- Outstanding protection against corrosion and wear
- Unique protection against chain joint stiffness
- Extremely eco-friendly

REXNORD

RexAthletic
good loading capacity
extended lubrication intervals

- Durable and low-maintenance
- Longer servicing intervals
- High loading capacity

REXNORD

RexCarbon
no lubrication
low noise

- Maintenance-free
- Low noise
- Eco-friendly

REXNORD

RexPlus
excellent corrosion resistance
high reliability

- Excellent resistance to rust and acids
- Highly reliable
- Fulfills hygiene requirements
- NSF H1 certification

REXNORD

RexPlusCarbon
no lubrication
excellent corrosion resistance

- Combination of RexPlus and RexCarbon
- Excellent resistance to rust and acids
- Maintenance-free
- NSF H1 certification

REXNORD

RexHiPro
good corrosion resistance
excellent loading capacity

- Outstanding corrosion resistance
- Long service life
- High loading capacity

Link-Belt
a brand of
REXNORD

- The optimum choice for light and medium duty
- Good cost-benefit ratio
- High availability

REXNORD

RexProX
RexPro lubrication
improved wear resistance
high fatigue resistance

- Extremely high loading capacity
- Long service life
- Outstanding protection against corrosion and wear

Leaf Chains

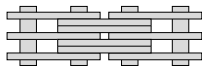

REXNORD

RexPro
RexPro lubrication
improved wear resistance
high fatigue resistance

- Outstanding protection against corrosion and wear
- Unique protection against chain joint stiffness
- Extremely eco-friendly

REXNORD

RexHiPro
good corrosion resistance
excellent loading capacity

- Outstanding corrosion resistance
- Long service life
- High loading capacity

REXNORD

RexAthletic
good loading capacity
extended lubrication intervals

- Durable and low-maintenance
- Longer servicing intervals
- High loading capacity
- Extreme wear resistance for double-length service life

REXDL
a brand of
REXNORD

- The optimum choice for light and medium duty
- Good cost-benefit ratio
- Good availability



Approved Performance from Rexnord

Roller chains H Series | American type



Roller chains H Series - American type

Approved Performance from Rexnord.

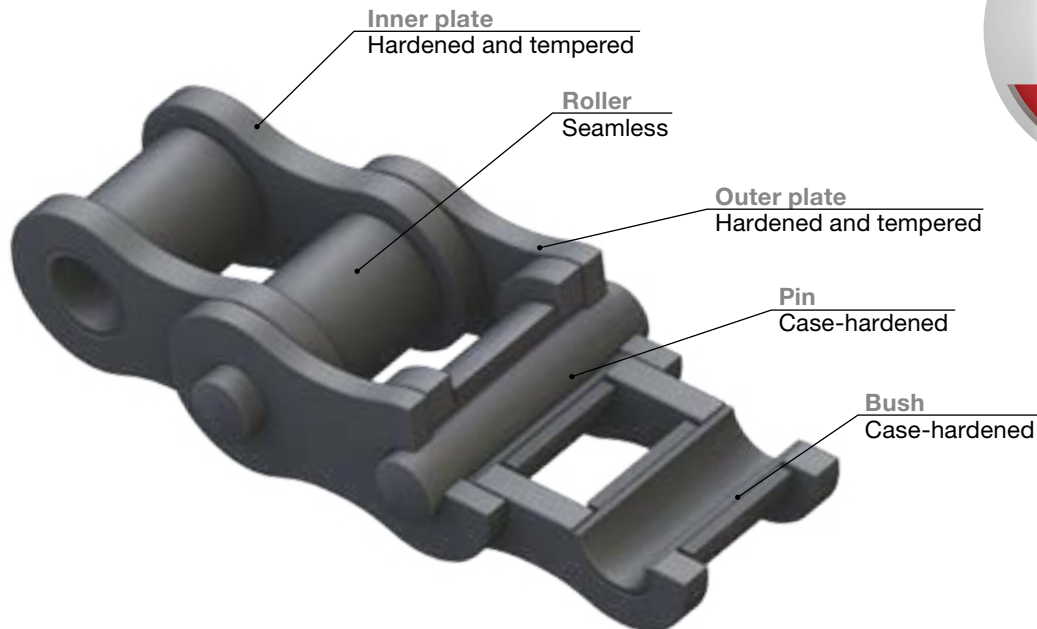

APPLICATIONS

- Light and medium duty
- Agricultural machinery, wood processing
- Textile industry

CHARACTERISTICS

- Established brand name
- Fulfils ISO quality requirements
- Rexnord guarantees the achievement of performance requirements

ADVANTAGES

- Good cost-benefit ratio
- Good availability
- Robust quality

LUBRICATION

- Contains no heavy metals
- Fulfils REACH requirements

Roller chains H Series - American type

Approved Performance from Rexnord.

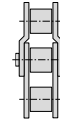

Simplex roller chains



Proven performance

- Fulfills ISO quality requirements
- Rexnord guarantees the achievement of performance requirements
- Optimum choice for light and medium duty



Purchasing policy

- Suppliers must comply with local environmental laws
- Suppliers must comply with Rexnord's ethical policy and internal guidelines
- Suppliers must take local environmental policy into account



Economical

- Good cost-benefit ratio
- Good availability



Simplex roller chains, ISO 606

Heavy series with higher fatigue strength (thicker plates)

Chain No.	Pitch		Width between inner plates	Roller diameter	Pin diameter	Width over inner link	Plate depth	Transverse pitch	Pin length	Connecting pin length	Bearing area	Required min. tensile strength DIN/ISO	Weight	Loose parts						
	p													b ₁ min.	d ₁ max.	d ₂ max.	b ₂ max.	g max.	e	a ₁ max.
	inch	mm	mm	mm	mm	mm	mm	mm	mm	mm	mm	cm ²	N	kg/m						
60 H-1	0.75	19.05	12.57	11.91	5.94	19.43	18.1	-	30.2	34.8	1.15	31 300	1.7					x	x	x
80 H-1	1.00	25.4	15.75	15.88	7.92	24.28	24.1	-	37.4	42.8	1.92	55 600	3.0					x	x	x
100 H-1	1.25	31.75	18.90	19.05	9.53	29.10	30.1	-	44.5	50.6	2.77	87 000	4.5						x	x
120 H-1	1.50	38.1	25.22	22.23	11.10	37.18	36.2	-	55.0	61.6	4.13	125 000	6.2						x	x
140 H-1	1.75	44.45	25.22	25.40	12.70	38.36	42.2	-	59.0	66.4	4.87	170 000	8.1						x	x
160 H-1	2.00	50.80	31.55	28.58	14.27	46.88	48.2	-	69.4	77.3	6.69	223 000	11.5						x	x

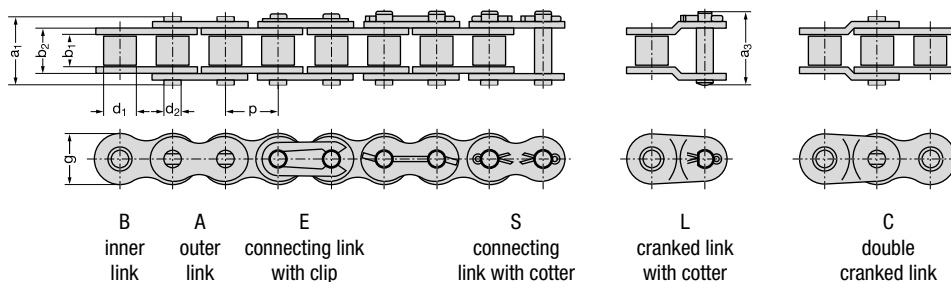

Roller chains H Series - American type

Approved Performance from Rexnord.

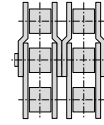

Duplex roller chains



Proven performance

- Fulfills ISO quality requirements
- Rexnord guarantees the achievement of performance requirements
- Optimum choice for light and medium duty



Purchasing policy

- Suppliers must comply with local environmental laws
- Suppliers must comply with Rexnord's ethical policy and internal guidelines
- Suppliers must take local environmental policy into account



Economical

- Good cost-benefit ratio
- Good availability

Duplex roller chains, ISO 606

Heavy series with higher fatigue strength (thicker plates)

Chain No.	Pitch		Width between inner plates	Roller diameter	Pin diameter	Width over inner link	Plate depth	Transverse pitch	Pin length	Connecting pin length	Bearing area	Required min. tensile strength DIN/ISO	Weight	Loose parts						
	p													b ₁ min.	d ₁ max.	d ₂ max.	b ₂ max.	g max.	e	a ₁ max.
	inch	mm	mm	mm	mm	mm	mm	mm	mm	mm	mm	cm ²	N	kg/m						
60 H-2	0.75	19.05	12.57	11.91	5.94	19.43	18.1	26.11	56.3	60.9	2.31	62 600	3.4						x	x
80 H-2	1.00	25.4	15.75	15.88	7.92	24.28	24.1	32.59	70.0	75.4	3.85	111 200	6.0						x	x
100 H-2	1.25	31.75	18.90	19.05	9.53	29.10	30.1	39.09	83.6	89.7	5.55	174 000	9.0						x	x
120 H-2	1.50	38.1	25.22	22.23	11.10	37.18	36.2	48.87	103.9	110.5	8.25	250 000	12.4						x	x
140 H-2	1.75	44.45	25.22	25.40	12.70	38.36	42.2	52.20	111.2	118.6	9.74	340 000	16.2						x	x
160 H-2	2.00	50.8	31.55	28.58	14.27	46.88	48.2	61.90	131.3	139.2	13.38	446 000	22.0						x	x

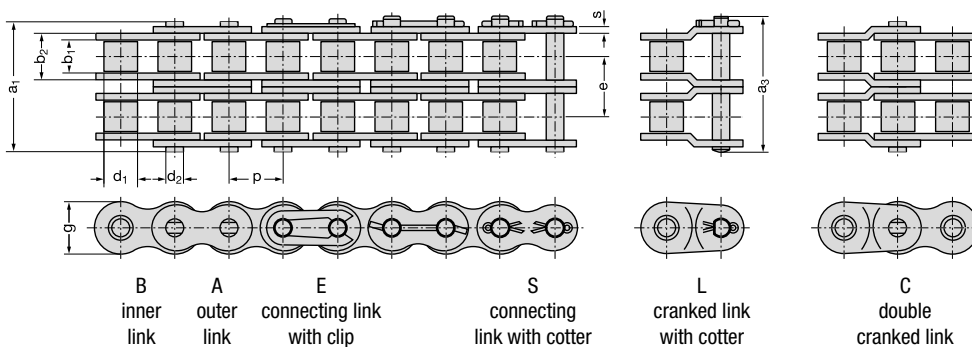



Overview Rexnord roller chains

Roller Chains

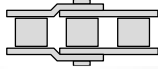

REXNORD

RexPro
RexPro lubrication
improved wear resistance
high fatigue resistance

- Outstanding protection against corrosion and wear
- Unique protection against chain joint stiffness
- Extremely eco-friendly

REXNORD

RexAthletic
good loading capacity
extended lubrication intervals

- Durable and low-maintenance
- Longer servicing intervals
- High loading capacity

REXNORD

RexCarbon
no lubrication
low noise

- Maintenance-free
- Low noise
- Eco-friendly

REXNORD

RexPlus
excellent corrosion resistance
high reliability

- Excellent resistance to rust and acids
- Highly reliable
- Fulfills hygiene requirements
- NSF H1 certification

REXNORD

RexPlusCarbon
no lubrication
excellent corrosion resistance

- Combination of RexPlus and RexCarbon
- Excellent resistance to rust and acids
- Maintenance-free
- NSF H1 certification

REXNORD

RexHiPro
good corrosion resistance
excellent loading capacity

- Outstanding corrosion resistance
- Long service life
- High loading capacity

Link-Belt
a brand of REXNORD

- The optimum choice for light and medium duty
- Good cost-benefit ratio
- High availability

REXNORD

RexProX
RexPro lubrication
improved wear resistance
high fatigue resistance

- Extremely high loading capacity
- Long service life
- Outstanding protection against corrosion and wear

Leaf Chains

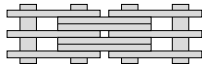

REXNORD

RexPro
RexPro lubrication
improved wear resistance
high fatigue resistance

- Outstanding protection against corrosion and wear
- Unique protection against chain joint stiffness
- Extremely eco-friendly

REXNORD

RexHiPro
good corrosion resistance
excellent loading capacity

- Outstanding corrosion resistance
- Long service life
- High loading capacity

REXNORD

RexAthletic
good loading capacity
extended lubrication intervals

- Durable and low-maintenance
- Longer servicing intervals
- High loading capacity
- Extreme wear resistance for double-length service life

REXDL
a brand of REXNORD

- The optimum choice for light and medium duty
- Good cost-benefit ratio
- Good availability



Approved Performance from Rexnord

Roller chains | European type | Stainless



Stainless roller chains - European type

Approved Performance from Rexnord.

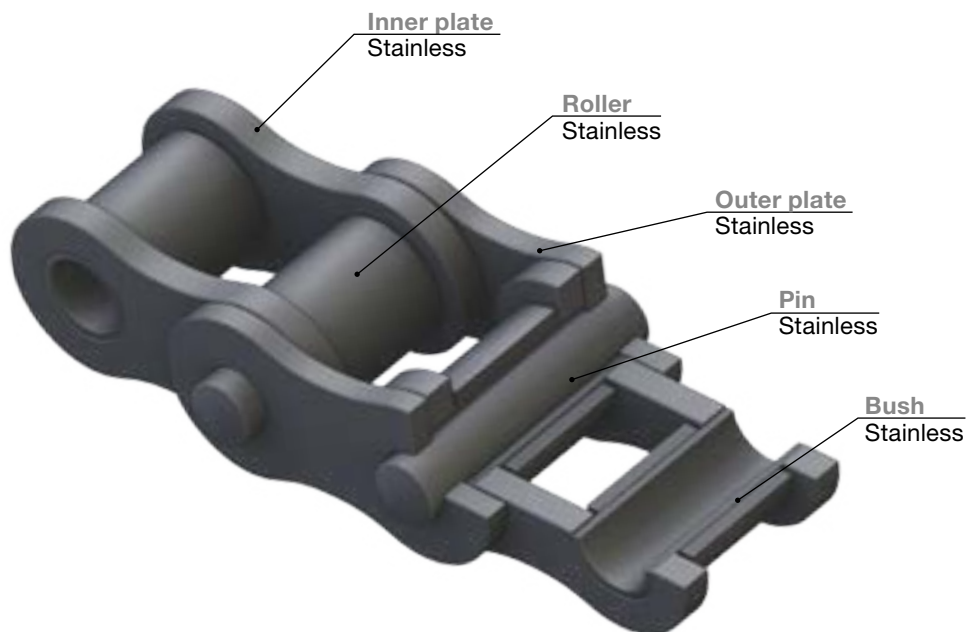

APPLICATIONS

- Light and medium duty
- Agricultural machinery, wood processing
- Textile industry

CHARACTERISTICS

- Established brand name
- Fulfils ISO quality requirements
- Rexnord guarantees the achievement of performance requirements

ADVANTAGES

- Good cost-benefit ratio
- Good availability
- Robust quality

LUBRICATION

- Contains no heavy metals
- Fulfils REACH requirements

Stainless Roller chains - European type

Approved Performance from Rexnord.

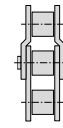

Simplex roller chains



Proven performance

- Fulfills ISO quality requirements
- Rexnord guarantees the achievement of performance requirements
- Optimum choice for light and medium duty



Purchasing policy

- Suppliers must comply with local environmental laws
- Suppliers must comply with Rexnord's ethical policy and internal guidelines
- Suppliers must take local environmental policy into account



Economical

- Good cost-benefit ratio
- Good availability



Simplex roller chains, ISO 606, stainless

Chain No.	Pitch		Width between inner plates	Roller diameter	Pin diameter	Width over inner link	Plate depth	Pin length	Connecting pin length	Bearing area	min. tensile strength	Weight	Loose parts					
	inch	mm											b ₁ min.	d ₁ max.	d ₂ max.	b ₂ max.	g max.	a ₁ max.
			mm	mm	mm	mm	mm	mm	mm	mm	cm ²	N	kg/m					
06 B-1 SS	0.375	9.525	5.72	6.35	3.28	8.53	8.2	13.5	16.8	0.28	5 300	0.4					x	
08 B-1 SS	0.50	12.7	7.75	8.51	4.45	11.30	11.8	17.0	20.9	0.50	10 700	0.7				x	x	
10 B-1 SS	0.625	15.875	9.65	10.16	5.08	13.28	14.7	19.6	23.7	0.67	13 300	0.9				x	x	
12 B-1 SS	0.75	19.05	11.68	12.07	5.72	15.62	16.2	22.7	27.3	0.89	17 300	1.2				x	x	
16 B-1 SS	1.00	25.4	17.02	15.88	8.28	25.45	21.0	36.1	41.5	2.11	36 000	2.6				x	x	x

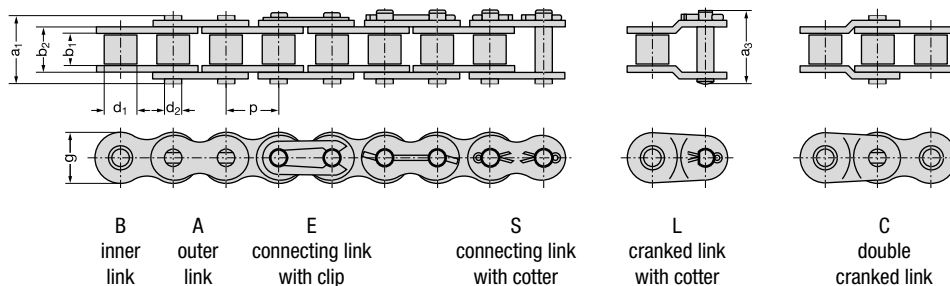

Stainless Roller chains - European type

Approved Performance from Rexnord.

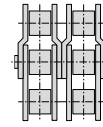

Duplex roller chains



Proven performance

- Fulfills ISO quality requirements
- Rexnord guarantees the achievement of performance requirements
- Optimum choice for light and medium duty



Purchasing policy

- Suppliers must comply with local environmental laws
- Suppliers must comply with Rexnord's ethical policy and internal guidelines
- Suppliers must take local environmental policy into account



Economical

- Good cost-benefit ratio
- Good availability

Duplex roller chains, ISO 606, stainless

Chain No.	Pitch		Width between inner plates	Roller diameter	Pin diameter	Width over inner link	Plate depth	Transverse pitch	Pin length	Connecting pin length	Bearing area	min. tensile strength	Weight	Loose parts							
	p													b ₁ min.	d ₁ max.	d ₂ max.	b ₂ max.	g max.	e	a ₁ max.	a ₃ max.
	inch	mm	mm	mm	mm	mm	mm	mm	mm	mm	mm	cm ²	N	kg/m							
08 B-2 SS	0.50	12.7	7.75	8.51	4.45	11.30	11.8	13.92	31.0	34.9	1.01	18 700	1.4					x	x		
10 B-2 SS	0.625	15.875	9.65	10.16	5.08	13.28	14.7	16.59	36.2	40.3	1.35	26 700	1.8					x	x		
12 B-2 SS	0.75	19.05	11.68	12.07	5.72	15.62	16.2	19.46	42.2	46.8	1.79	34 700	2.3					x	x		
16 B-2 SS	1.00	25.4	17.02	15.88	8.28	25.45	21.0	31.88	68.0	73.4	4.21	63 600	5.3					x	x	x	

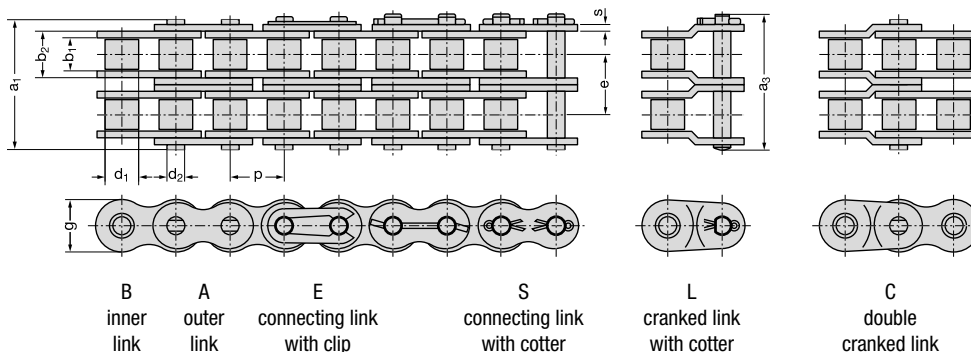



Overview Rexnord roller chains

Roller Chains

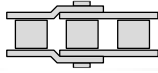

REXNORD

RexPro
RexPro lubrication
improved wear resistance
high fatigue resistance

- Outstanding protection against corrosion and wear
- Unique protection against chain joint stiffness
- Extremely eco-friendly

REXNORD

RexAthletic
good loading capacity
extended lubrication intervals

- Durable and low-maintenance
- Longer servicing intervals
- High loading capacity

REXNORD

RexCarbon
no lubrication
low noise

- Maintenance-free
- Low noise
- Eco-friendly

REXNORD

RexPlus
excellent corrosion resistance
high reliability

- Excellent resistance to rust and acids
- Highly reliable
- Fulfills hygiene requirements
- NSF H1 certification

REXNORD

RexPlusCarbon
no lubrication
excellent corrosion resistance

- Combination of RexPlus and RexCarbon
- Excellent resistance to rust and acids
- Maintenance-free
- NSF H1 certification

REXNORD

RexHiPro
good corrosion resistance
excellent loading capacity

- Outstanding corrosion resistance
- Long service life
- High loading capacity

Link-Belt
a brand of
REXNORD

- The optimum choice for light and medium duty
- Good cost-benefit ratio
- High availability

REXNORD

RexProX
RexPro lubrication
improved wear resistance
high fatigue resistance

- Extremely high loading capacity
- Long service life
- Outstanding protection against corrosion and wear

Leaf Chains

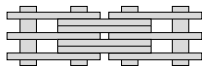

REXNORD

RexPro
RexPro lubrication
improved wear resistance
high fatigue resistance

- Outstanding protection against corrosion and wear
- Unique protection against chain joint stiffness
- Extremely eco-friendly

REXNORD

RexHiPro
good corrosion resistance
excellent loading capacity

- Outstanding corrosion resistance
- Long service life
- High loading capacity

REXNORD

RexAthletic
good loading capacity
extended lubrication intervals

- Durable and low-maintenance
- Longer servicing intervals
- High loading capacity
- Extreme wear resistance for double-length service life

REXDL
a brand of
REXNORD

- The optimum choice for light and medium duty
- Good cost-benefit ratio
- Good availability



Approved Performance from Rexnord

Roller chains | American type | Stainless



Stainless Roller chains - American type

Approved Performance from Rexnord.

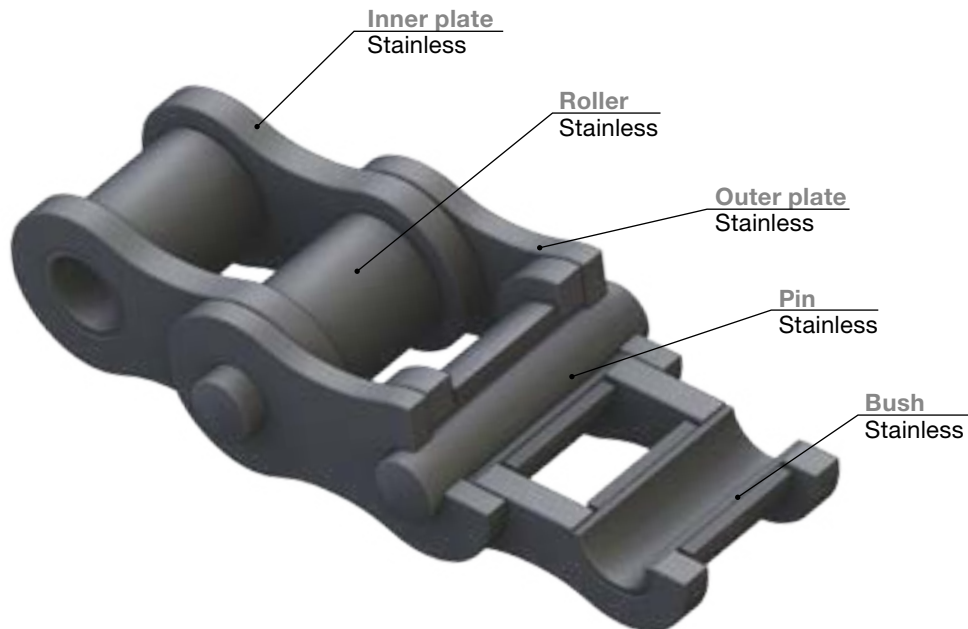

APPLICATIONS

- Light and medium duty
- Agricultural machinery, wood processing
- Textile industry

CHARACTERISTICS

- Established brand name
- Fulfils ISO quality requirements
- Rexnord guarantees the achievement of performance requirements

ADVANTAGES

- Good cost-benefit ratio
- Good availability
- Robust quality

LUBRICATION

- Contains no heavy metals
- Fulfils REACH requirements

Stainless Roller chains - American type

Approved Performance from Rexnord.

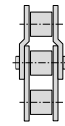

Simplex roller chains



Proven performance

- Fulfills ISO quality requirements
- Rexnord guarantees the achievement of performance requirements
- Optimum choice for light and medium duty



Purchasing policy

- Suppliers must comply with local environmental laws
- Suppliers must comply with Rexnord's ethical policy and internal guidelines
- Suppliers must take local environmental policy into account



Economical

- Good cost-benefit ratio
- Good availability



Simplex roller chains, ISO 606, stainless

Chain No.	Pitch		Width between inner plates		Roller diameter	Pin diameter	Width over inner link	Plate depth	Transverse pitch	Pin length	Connecting pin length	Bearing area	min. tensile strength	Weight	Loose parts					
	p		b ₁ min.	d ₁ max.	d ₂ max.	b ₂ max.	g max.	e	a ₁ max.	a ₃ max.	A	F _b	q	A	B	C	E	L	S	
	inch	mm	mm	mm	mm	mm	mm	mm	mm	mm	mm	cm ²	N	kg/m						
25-1 SS	0.25	6.35	3.18	3.30	2.32	4.80	5.8	-	7.8	8.6	0.11	2 100	0.1				x	x		
35-1 SS	0.38	9.525	4.78	5.08	3.59	7.46	9.0	-	11.8	13.6	0.27	4 700	0.3				x	x		
40-1 SS	0.50	12.7	7.85	7.92	3.96	11.17	12.0	-	17.8	21.7	0.44	8 300	0.6				x	x		
50-1 SS	0.625	15.875	9.40	10.16	5.08	13.84	15.0	-	21.8	25.9	0.70	13 100	1.0				x	x		
60-1 SS	0.75	19.05	12.57	11.91	5.94	17.75	18.1	-	26.9	31.5	1.05	18 800	1.5				x	x		
80-1 SS	1.00	25.4	15.75	15.88	7.92	22.60	24.1	-	33.5	38.9	1.79	33 400	2.6				x	x	x	

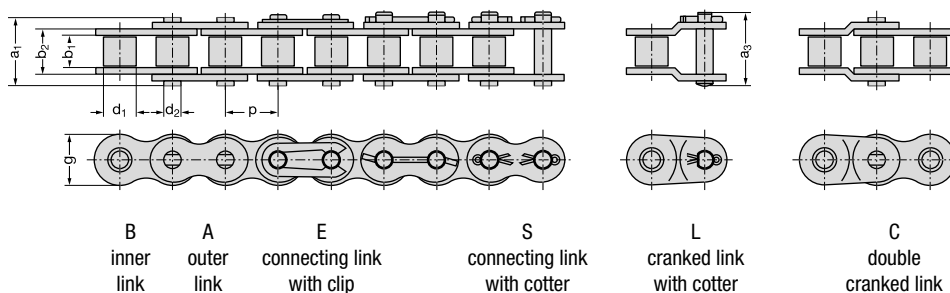

Stainless Roller chains - American type

Approved Performance from Rexnord.

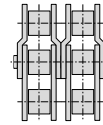

Duplex roller chains



Proven performance

- Fulfills ISO quality requirements
- Rexnord guarantees the achievement of performance requirements
- Optimum choice for light and medium duty



Purchasing policy

- Suppliers must comply with local environmental laws
- Suppliers must comply with Rexnord's ethical policy and internal guidelines
- Suppliers must take local environmental policy into account



Economical

- Good cost-benefit ratio
- Good availability

Duplex roller chains, ISO 606, stainless

Chain No.	Pitch		Width between inner plates	Roller diameter	Pin diameter	Width over inner link	Plate depth	Transverse pitch	Pin length	Connecting pin length	Bearing area	min. tensile strength	Weight	Loose parts					
	p	p												b ₁ min.	d ₁ max.	d ₂ max.	b ₂ max.	g max.	e
	inch	mm	mm	mm	mm	mm	mm	mm	mm	mm	mm	cm ²	N	kg/m					
40-2 SS	0.50	12.7	7.85	7.92	3.96	11.17	12.0	14.38	32.3	36.2	0.88	16 700	1.2				x	x	
60-2 SS	0.75	19.05	12.57	11.91	5.94	17.75	18.1	22.78	49.8	54.4	2.11	37 600	3.0				x	x	
80-2 SS	1.00	25.4	15.75	15.88	7.92	22.60	24.1	29.29	62.7	68.1	3.58	66 700	5.2				x	x	x

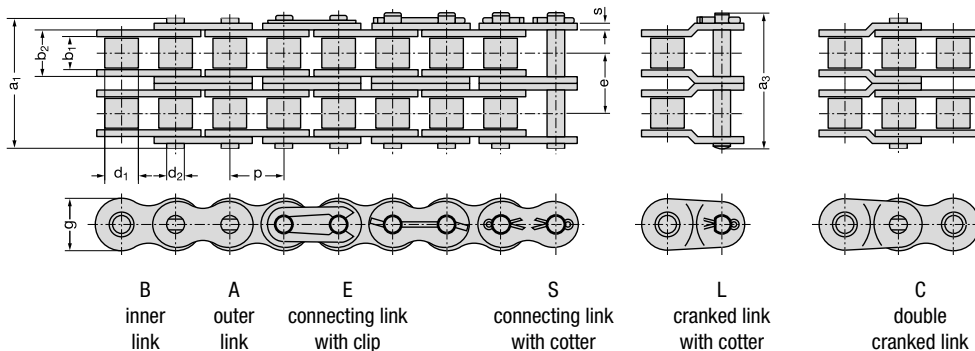



Overview Rexnord roller chains

Roller Chains

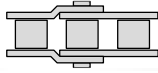

REXNORD

RexPro
RexPro lubrication
improved wear resistance
high fatigue resistance

- Outstanding protection against corrosion and wear
- Unique protection against chain joint stiffness
- Extremely eco-friendly

REXNORD

RexAthletic
good loading capacity
extended lubrication intervals

- Durable and low-maintenance
- Longer servicing intervals
- High loading capacity

REXNORD

RexCarbon
no lubrication
low noise

- Maintenance-free
- Low noise
- Eco-friendly

REXNORD

RexPlus
excellent corrosion resistance
high reliability

- Excellent resistance to rust and acids
- Highly reliable
- Fulfills hygiene requirements
- NSF H1 certification

REXNORD

RexPlusCarbon
no lubrication
excellent corrosion resistance

- Combination of RexPlus and RexCarbon
- Excellent resistance to rust and acids
- Maintenance-free
- NSF H1 certification

REXNORD

RexHiPro
good corrosion resistance
excellent loading capacity

- Outstanding corrosion resistance
- Long service life
- High loading capacity

Link-Belt
a brand of REXNORD

- The optimum choice for light and medium duty
- Good cost-benefit ratio
- High availability

REXNORD

RexProX
RexPro lubrication
improved wear resistance
high fatigue resistance

- Extremely high loading capacity
- Long service life
- Outstanding protection against corrosion and wear

Leaf Chains

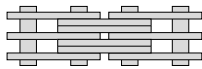

REXNORD

RexPro
RexPro lubrication
improved wear resistance
high fatigue resistance

- Outstanding protection against corrosion and wear
- Unique protection against chain joint stiffness
- Extremely eco-friendly

REXNORD

RexHiPro
good corrosion resistance
excellent loading capacity

- Outstanding corrosion resistance
- Long service life
- High loading capacity

REXNORD

RexAthletic
good loading capacity
extended lubrication intervals

- Durable and low-maintenance
- Longer servicing intervals
- High loading capacity
- Extreme wear resistance for double-length service life

REXDL
a brand of REXNORD

- The optimum choice for light and medium duty
- Good cost-benefit ratio
- Good availability

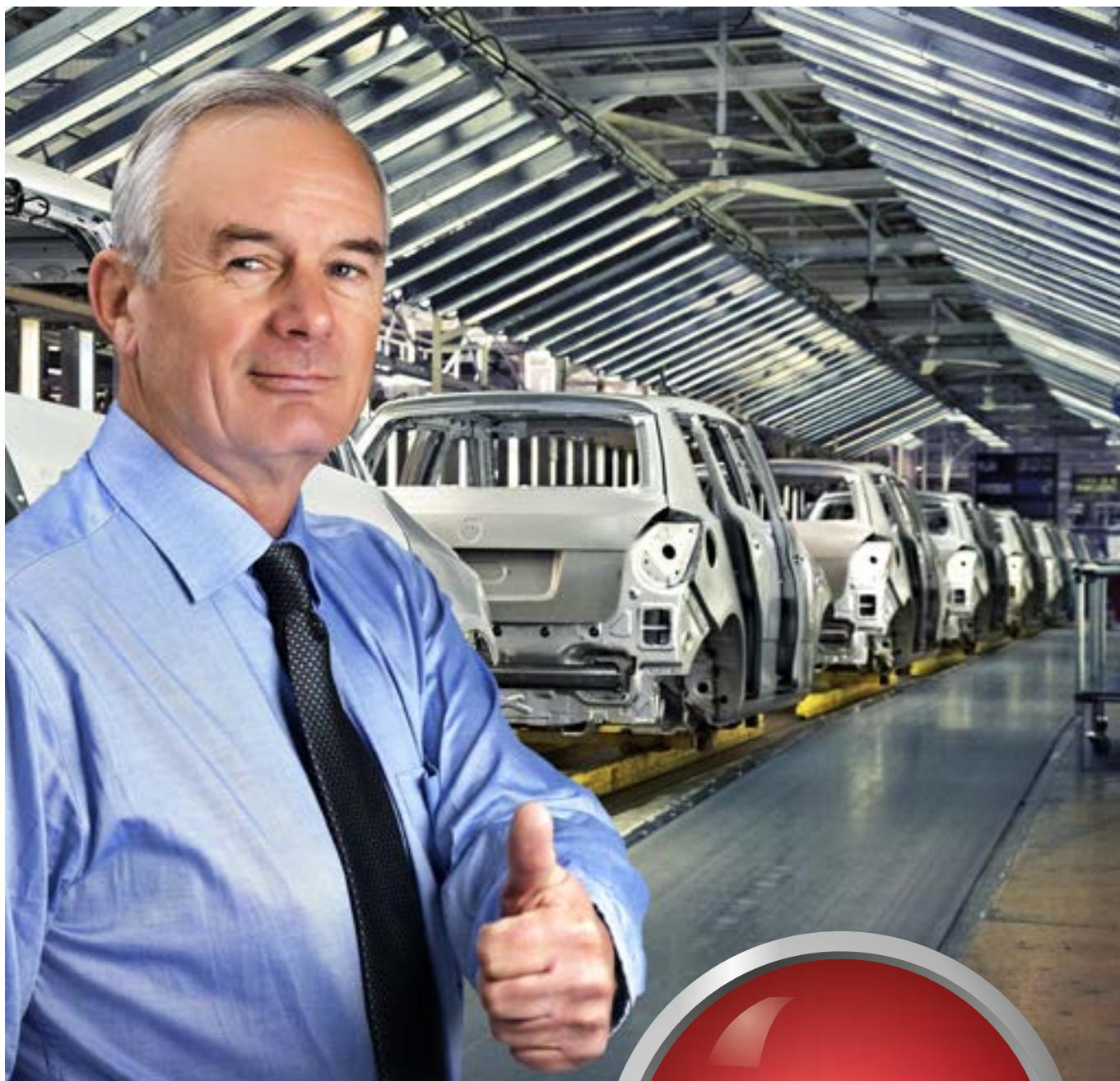

Approved Performance from Rexnord

Roller chains with straight link plates



Roller chains with straight link plates

Approved Performance from Rexnord.

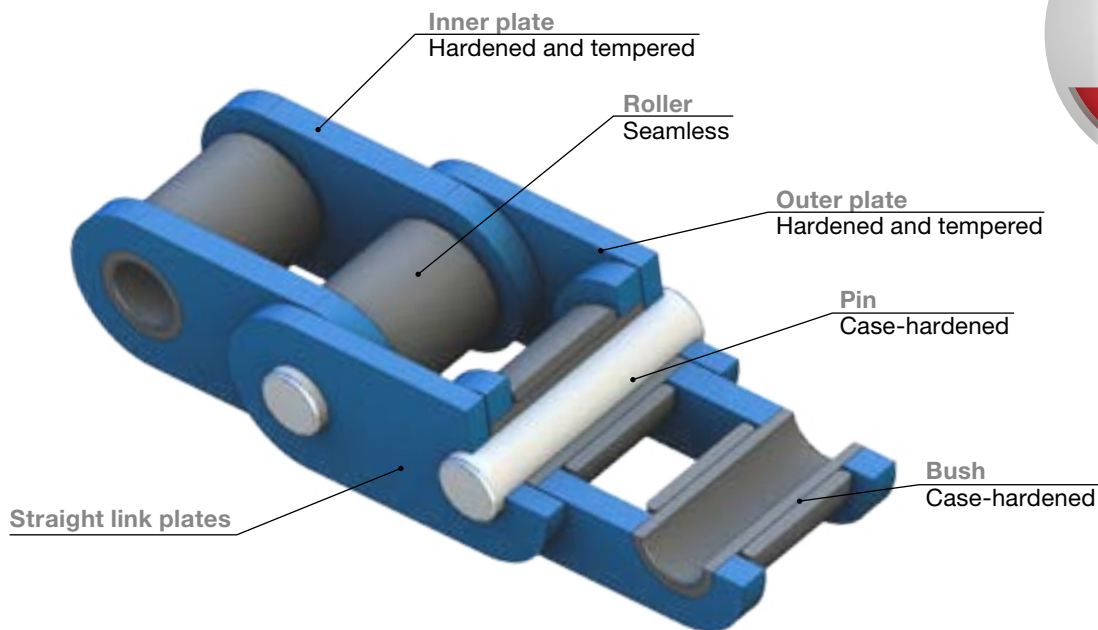

APPLICATIONS

- Light and medium duty
- Agricultural machinery, wood processing
- Textile industry

CHARACTERISTICS

- Established brand name
- Fulfils ISO quality requirements
- Rexnord guarantees the achievement of performance requirements

ADVANTAGES

- Good cost-benefit ratio
- Good availability
- Robust quality

LUBRICATION

- Contains no heavy metals
- Fulfils REACH requirements

Roller chains with straight link plates

Approved Performance from Rexnord.

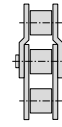

Simplex roller chains



Proven performance

- Fulfills ISO quality requirements
- Rexnord guarantees the achievement of performance requirements
- Optimum choice for light and medium duty



Purchasing policy

- Suppliers must comply with local environmental laws
- Suppliers must comply with Rexnord's ethical policy and internal guidelines
- Suppliers must take local environmental policy into account



Economical

- Good cost-benefit ratio
- Good availability



Simplex roller chains with straight link plates, ISO 606

Chain No.	Pitch		Width between inner plates		Roller diameter	Pin diameter	Width over inner link	Plate depth	Transverse pitch	Pin length	Connecting pin length	Bearing area	Required min. tensile strength DIN / ISO	Weight	Loose parts					
	p		b ₁ min.	d ₁ max.	d ₂ max.	b ₂ max.	g max.	e	a ₁ max.	a ₃ max.	A	F _u	q	A	B	C	E	L	S	
	inch	mm	mm	mm	mm	mm	mm	mm	mm	mm	mm	cm ²	N	kg/m						
06 B-1 GL	0.375	9.525	5.72	6.35	3.28	8.53	8.2	-	13.5	16.8	0.28	8 900	0.4	x	x	x				
08 B-1 GL	0.50	12.7	7.75	8.51	4.45	11.30	11.8	-	17.0	20.9	0.50	17 800	0.8	x		x				
10 B-1 GL	0.625	15.875	9.65	10.16	5.08	13.28	14.7	-	19.6	23.7	0.67	22 200	1.0	x		x				
12 B-1 GL	0.75	19.05	11.68	12.07	5.72	15.62	16.2	-	22.7	27.3	0.89	28 900	1.3	x		x				
16 B-1 GL	1.00	25.4	17.02	15.88	8.28	25.45	21.0	-	36.1	41.5	2.11	60 000	2.9	x		x	x			

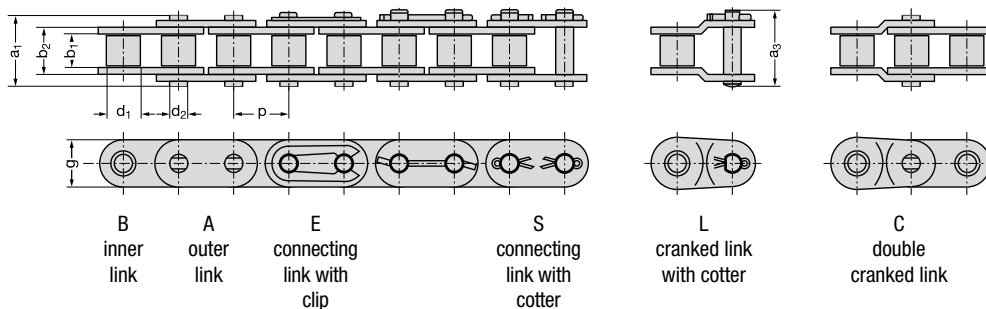

Roller chains with straight link plates

Approved Performance from Rexnord.

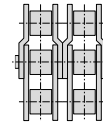

Duplex roller chains



Proven performance

- Fulfills ISO quality requirements
- Rexnord guarantees the achievement of performance requirements
- Optimum choice for light and medium duty



Purchasing policy

- Suppliers must comply with local environmental laws
- Suppliers must comply with Rexnord's ethical policy and internal guidelines
- Suppliers must take local environmental policy into account



Economical

- Good cost-benefit ratio
- Good availability

Duplex roller chains with straight link plates, ISO 606

Chain No.	Pitch		Width between inner plates		Roller diameter	Pin diameter	Width over inner link	Plate depth	Transverse pitch	Pin length	Connecting pin length	Bearing area	Required min. tensile strength DIN / ISO	Weight	Loose parts				
	p		b ₁ min.	d ₁ max.	d ₂ max.	b ₂ max.	g max.	e	a ₁ max.	a ₃ max.	A	F _u	q	A	B	C	E	L	S
	inch	mm	mm	mm	mm	mm	mm	mm	mm	mm	mm	cm ²	N	kg/m					
06 B-2 GL	0.375	9.525	5.72	6.35	3.28	8.53	8.2	10.24	23.8	27.1	0.56	19 600	0.8	x	x	x			
08 B-2 GL	0.50	12.7	7.75	8.51	4.45	11.30	11.8	13.92	31.0	34.9	1.01	31 100	1.5	x		x			
10 B-2 GL	0.625	15.875	9.65	10.16	5.08	13.28	14.7	16.59	36.2	40.3	1.35	44 500	1.9	x		x			
12 B-2 GL	0.75	19.05	11.68	12.07	5.72	15.62	16.2	19.46	42.2	46.8	1.79	57 800	1.5	x		x			
16 B-2 GL	1.00	25.4	17.02	15.88	8.28	25.45	21.0	31.88	68.0	73.4	4.21	106 000	5.7	x		x	x		

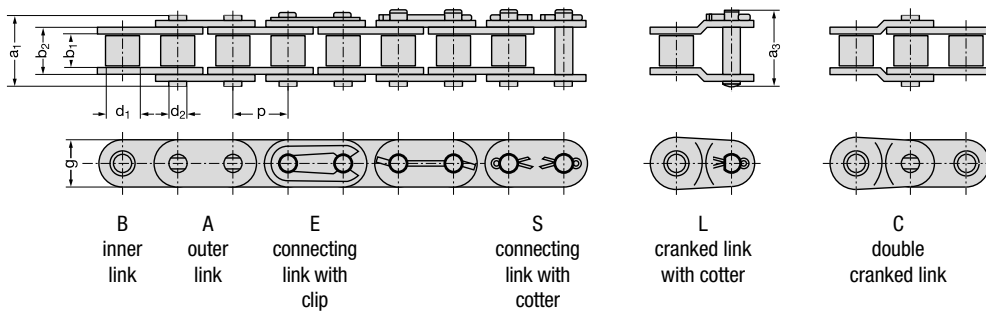



Overview Rexnord roller chains

Roller Chains

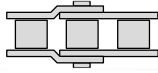

REXNORD

RexPro
RexPro lubrication
improved wear resistance
high fatigue resistance

- Outstanding protection against corrosion and wear
- Unique protection against chain joint stiffness
- Extremely eco-friendly

REXNORD

RexAthletic
good loading capacity
extended lubrication intervals

- Durable and low-maintenance
- Longer servicing intervals
- High loading capacity

REXNORD

RexCarbon
no lubrication
low noise

- Maintenance-free
- Low noise
- Eco-friendly

REXNORD

RexPlus
excellent corrosion resistance
high reliability

- Excellent resistance to rust and acids
- Highly reliable
- Fulfills hygiene requirements
- NSF H1 certification

REXNORD

RexPlusCarbon
no lubrication
excellent corrosion resistance

- Combination of RexPlus and RexCarbon
- Excellent resistance to rust and acids
- Maintenance-free
- NSF H1 certification

REXNORD

RexHiPro
good corrosion resistance
excellent loading capacity

- Outstanding corrosion resistance
- Long service life
- High loading capacity

Link-Belt
a brand of
REXNORD

- The optimum choice for light and medium duty
- Good cost-benefit ratio
- High availability

REXNORD

RexProX
RexPro lubrication
improved wear resistance
high fatigue resistance

- Extremely high loading capacity
- Long service life
- Outstanding protection against corrosion and wear

Leaf Chains

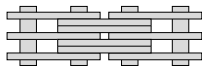

REXNORD

RexPro
RexPro lubrication
improved wear resistance
high fatigue resistance

- Outstanding protection against corrosion and wear
- Unique protection against chain joint stiffness
- Extremely eco-friendly

REXNORD

RexHiPro
good corrosion resistance
excellent loading capacity

- Outstanding corrosion resistance
- Long service life
- High loading capacity

REXNORD

RexAthletic
good loading capacity
extended lubrication intervals

- Durable and low-maintenance
- Longer servicing intervals
- High loading capacity
- Extreme wear resistance for double-length service life

REXDL
a brand of
REXNORD

- The optimum choice for light and medium duty
- Good cost-benefit ratio
- Good availability



Approved Performance from Rexnord

Double pitch roller chains



Double pitch roller chains

Approved Performance from Rexnord.

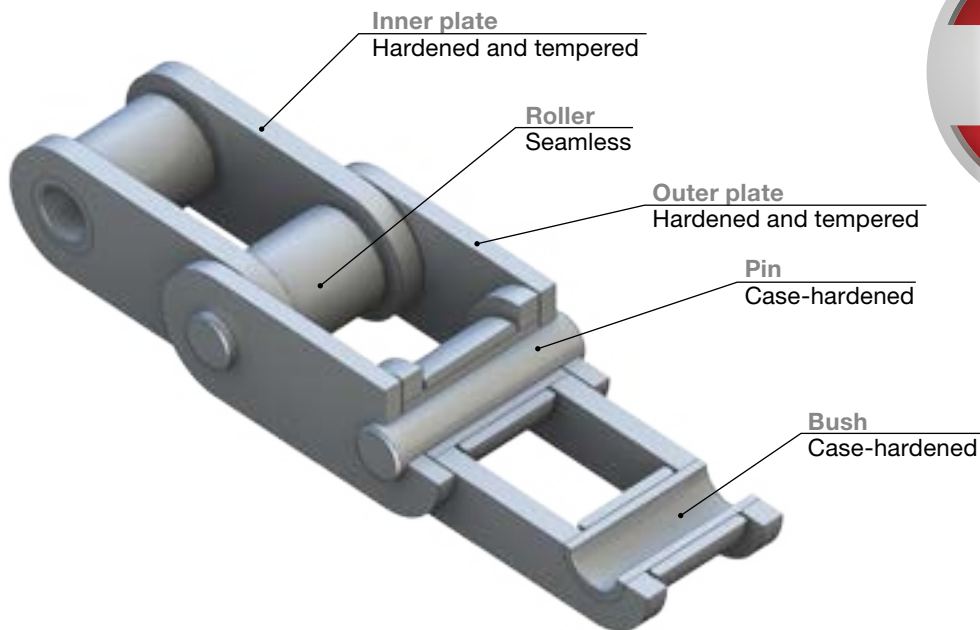

APPLICATIONS

- Light and medium duty
- Agricultural machinery, wood processing
- Textile industry

CHARACTERISTICS

- Established brand name
- Fulfils ISO quality requirements
- Rexnord guarantees the achievement of performance requirements

ADVANTAGES

- Good cost-benefit ratio
- Good availability
- Robust quality

LUBRICATION

- Contains no heavy metals
- Fulfils REACH requirements

Double pitch roller chains - European type

Approved Performance from Rexnord.



Proven performance

- Fulfills ISO quality requirements
- Rexnord guarantees the achievement of performance requirements
- Optimum choice for light and medium duty



Purchasing policy

- Suppliers must comply with local environmental laws
- Suppliers must comply with Rexnord's ethical policy and internal guidelines
- Suppliers must take local environmental policy into account



Economical

- Good cost-benefit ratio
- Good availability



Double pitch roller chains, ISO 1275

Chain No.	Pitch		Width between inner plates	Roller diameter	Pin diameter	Width over inner link	Plate depth	Transverse pitch	Pin length	Connecting pin length	Bearing area	Required min. tensile strength DIN/ISO	Weight	Loose parts						
	p	p												b ₁ min.	d ₁ max.	d ₂ max.	b ₂ max.	g max.	e	a ₁ max.
	inch	mm	mm	mm	mm	mm	mm	mm	mm	mm	mm	cm ²	N	kg/m						
208 B	1.00	25.4	7.75	8.51	4.45	11.30	11.5	-	17.0	20.9	0.50	17 800	0.5						x	x
210 B	1.25	31.75	9.65	10.16	5.08	13.28	14.5	-	19.6	23.7	0.67	22 200	0.6						x	x
212 B	1.50	38.1	11.68	12.07	5.72	15.62	15.9	-	22.7	27.3	0.89	28 900	0.7						x	x
216 B	2.00	50.8	17.02	15.88	8.28	25.45	21.4	-	36.1	41.5	2.11	60 000	1.7						x	x

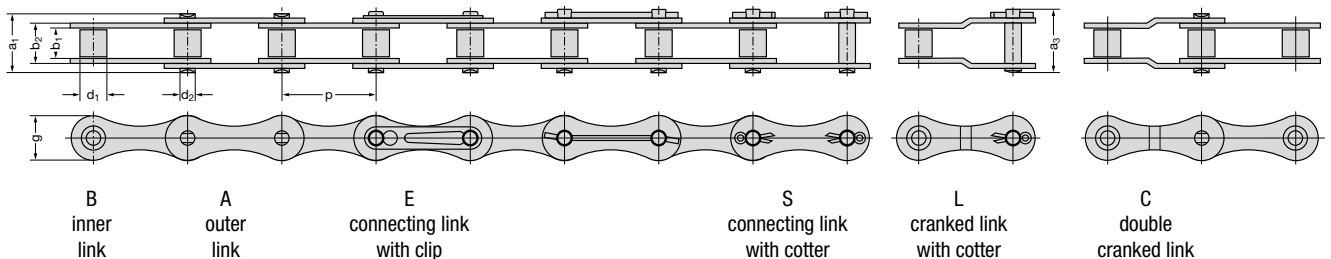

Double pitch roller chains - American type

Approved Performance from Rexnord.



Proven performance

- Fulfills ISO quality requirements
- Rexnord guarantees the achievement of performance requirements
- Optimum choice for light and medium duty



Purchasing policy

- Suppliers must comply with local environmental laws
- Suppliers must comply with Rexnord's ethical policy and internal guidelines
- Suppliers must take local environmental policy into account



Economical

- Good cost-benefit ratio
- Good availability

Double pitch roller chains, ISO 1275

Chain No.	Pitch		Width between inner plates	Roller diameter	Pin diameter	Width over inner link	Plate depth	Transverse pitch	Pin length	Connecting pin length	Bearing area	Required min. tensile strength DIN/ISO	Weight	Loose parts						
	p													b ₁ min.	d ₁ max.	d ₂ max.	b ₂ max.	g max.	e	a ₁ max.
	inch	mm	mm	mm	mm	mm	mm	mm	mm	mm	mm	cm ²	N	kg/m						
208 A	1.00	25.4	7.85	7.92	3.96	11.17	12.0	-	17.8	21.7	0.44	13 900	0.4					x	x	x
210 A	1.25	31.75	9.40	10.16	5.08	13.84	15.0	-	21.8	25.9	0.70	21 800	0.7					x	x	
212 A	1.50	38.1	12.57	11.91	5.94	17.75	18.1	-	26.9	31.5	1.05	31 300	1.0					x	x	
216 B	2.00	50.8	15.75	15.88	7.92	22.60	24.1	-	33.5	38.9	1.79	55 600	1.6						x	x

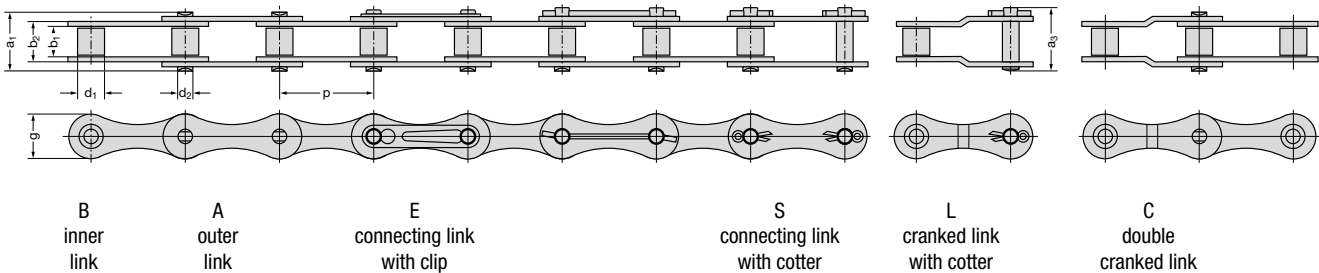

Double pitch roller chains with straight link plates

Approved Performance from Rexnord.



Proven performance

- Fulfills ISO quality requirements
- Rexnord guarantees the achievement of performance requirements
- Optimum choice for light and medium duty



Purchasing policy

- Suppliers must comply with local environmental laws
- Suppliers must comply with Rexnord's ethical policy and internal guidelines
- Suppliers must take local environmental policy into account



Economical

- Good cost-benefit ratio
- Good availability

Double pitch roller chains with straight link plates, ISO 1275

Chain No.	Pitch		Width between inner plates	Roller diameter	Pin diameter	Width over inner link	Plate depth	Transverse pitch	Pin length	Connecting pin length	Bearing area	Required min. tensile strength DIN/ISO	Weight	Loose parts						
	p	p												b ₁ min.	d ₁ max.	d ₂ max.	b ₂ max.	g max.	e	a ₁ max.
	inch	mm	mm	mm	mm	mm	mm	mm	mm	mm	mm	cm ²	N	kg/m						
C 2040	1.00	25.4	7.85	7.92	3.96	11.17	12.0	-	17.8	21.7	0.44	13 900	0.5					x	x	
C 2050	1.25	31.75	9.40	10.16	5.08	13.84	15.0	-	21.8	25.9	0.70	21 800	0.8					x	x	x
C 2060 H	1.50	38.1	12.57	11.91	5.94	19.43	18.1	-	30.2	34.8	1.15	31 300	1.5					x	x	x
C 2080 H	2.00	50.8	15.75	15.88	7.92	24.28	24.1	-	37.4	42.8	1.92	55 600	2.4						x	x

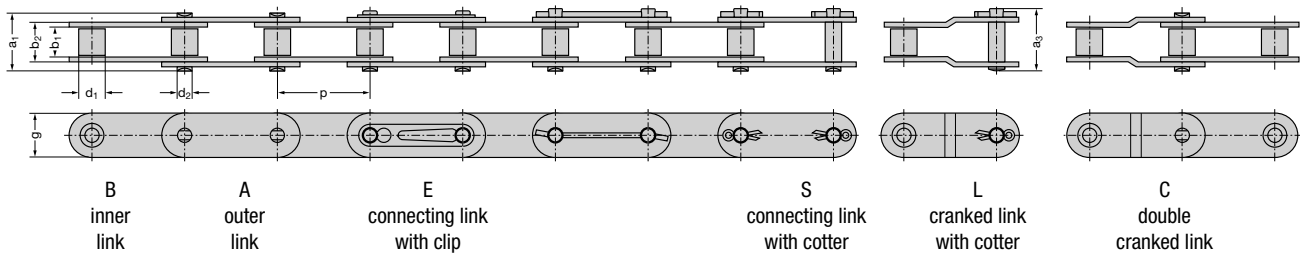



Overview Rexnord roller chains

Roller Chains

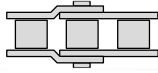

REXNORD

RexPro
RexPro lubrication
improved wear resistance
high fatigue resistance

- Outstanding protection against corrosion and wear
- Unique protection against chain joint stiffness
- Extremely eco-friendly

REXNORD

RexAthletic
good loading capacity
extended lubrication intervals

- Durable and low-maintenance
- Longer servicing intervals
- High loading capacity

REXNORD

RexCarbon
no lubrication
low noise

- Maintenance-free
- Low noise
- Eco-friendly

REXNORD

RexPlus
excellent corrosion resistance
high reliability

- Excellent resistance to rust and acids
- Highly reliable
- Fulfills hygiene requirements
- NSF H1 certification

REXNORD

RexPlusCarbon
no lubrication
excellent corrosion resistance

- Combination of RexPlus and RexCarbon
- Excellent resistance to rust and acids
- Maintenance-free
- NSF H1 certification

REXNORD

RexHiPro
good corrosion resistance
excellent loading capacity

- Outstanding corrosion resistance
- Long service life
- High loading capacity

Link-Belt
a brand of REXNORD

- The optimum choice for light and medium duty
- Good cost-benefit ratio
- High availability

REXNORD

RexProX
RexPro lubrication
improved wear resistance
high fatigue resistance

- Extremely high loading capacity
- Long service life
- Outstanding protection against corrosion and wear

Leaf Chains

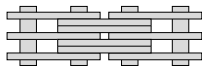

REXNORD

RexPro
RexPro lubrication
improved wear resistance
high fatigue resistance

- Outstanding protection against corrosion and wear
- Unique protection against chain joint stiffness
- Extremely eco-friendly

REXNORD

RexHiPro
good corrosion resistance
excellent loading capacity

- Outstanding corrosion resistance
- Long service life
- High loading capacity

REXNORD

RexAthletic
good loading capacity
extended lubrication intervals

- Durable and low-maintenance
- Longer servicing intervals
- High loading capacity
- Extreme wear resistance for double-length service life

REXDL
a brand of REXNORD

- The optimum choice for light and medium duty
- Good cost-benefit ratio
- Good availability