



Extreme Performance from Rexnord

RexPro-X

REXNORD

RexProX
RexPro lubrication
improved wear resistance
high fatigue resistance



**Extremely robust
and durable**

through reinforced link
plates and pins

RexPro - X

Extreme Performance from Rexnord.

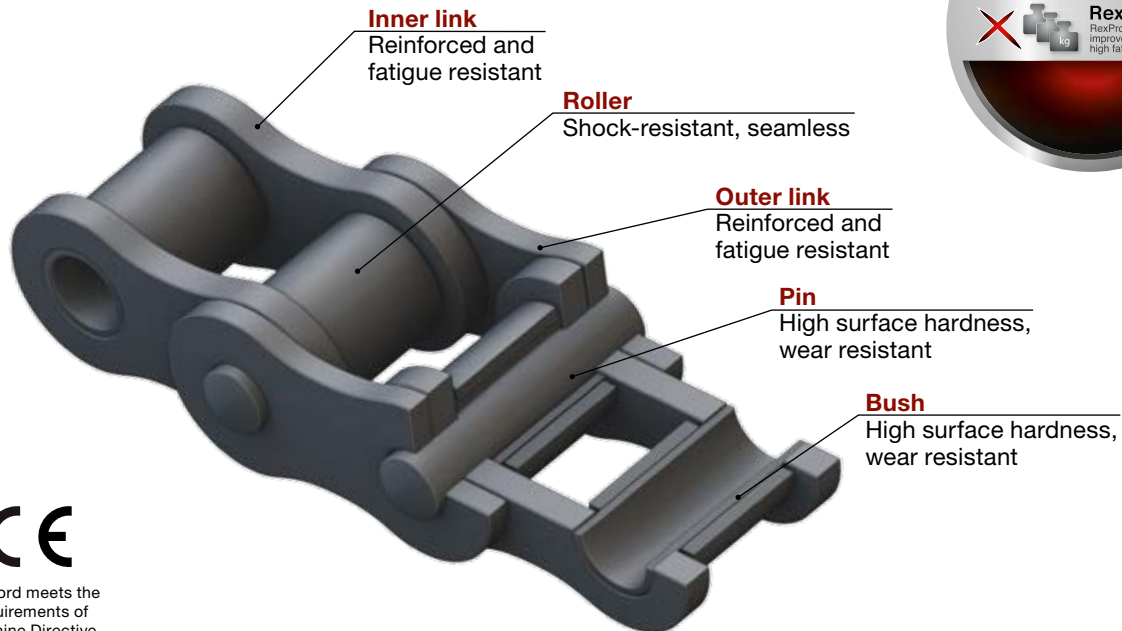

Rexnord meets the requirements of Machine Directive 2006/42/EC

APPLICATIONS

- Drills
- Road construction
- Agriculture and forestry

CHARACTERISTICS

- Complies with the excellent RexPro standards
- Enlarged bearing area
- Higher tensile strength
- Maximum fatigue resistance
- Compatible with European type

ADVANTAGES

- For high-performance power transmission
- Extremely high impact strength
- Extremely robust, even under difficult conditions

LUBRICATION

- Excellent protection through RexPro lubrication without heavy metals
- Operating temperature range: -30° C to +130° C (can be extended -40° C to +250° C)
- Outstanding surface adhesion; drip resistant even at high temperatures
- Contains no heavy metals; Teflon- and silicone-free

RexPro - X

Extreme Performance from Rexnord.

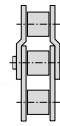

Simplex roller chains



Applications & Characteristics

- For the heavy-duty drives and lifting purposes
- Extremely high loading capacity



Maintenance & Service life

- Excellent protection through RexPro lubrication
- Extremely robust
- Long service life



Eco-friendly

- Through RexPro lubrication
- Contains no heavy metals; Teflon and silicone free



Rexnord meets the requirements of Machine Directive 2006/42/EC

Simplex roller chains for heavy-duty drives and lifting purposes

Chain No.	Pitch		Width between inner plates		Roller diameter	Pin diameter	Width over inner link	Link plate height	Pin length	Connecting pin length	Bearing area	Minimum breaking load	Average tensile strength	Weight	Loose parts					
	inch	mm	b ₁ min	d ₁ max	d ₂ max	b ₂ max	g max	a ₁ max	a ₃ max	A	F _u	F _u	q	A	B	S	C	E	L	
			mm	mm	mm	mm	mm	mm	mm	mm	mm	cm ²	N	N	kg/m					
Re 480	0.75	19.05	11.68	12.07	6.10	17.23	16.8	25.0	29.5	1.05	40 000	50 000	1.5	x	x	x		x	x	
KRV 12	1.00	25.40	12.70	19.05	10.19	25.70	24.0	40.1	45.5	2.61	117 500	140 000	4.4	x	x	x				
R 25 SH	1.00	25.4	17.02	15.88	8.28	25.40	24.0	36.1	41.5	2.10	85 000	90 000	3.2	x	x	x	x		x	
R 31 SH	1.25	31.75	19.56	19.05	10.19	32.00	29.2	46.0	52.1	3.25	150 000	170 000	5.3	x	x	x				
R 38 SH	1.50	38.10	25.40	25.40	14.63	40.00	37.2	56.7	63.3	5.85	235 000	250 000	7.8	x	x	x				
R 44 SH	1.75	44.45	30.99	27.94	15.90	46.50	40.8	66.3	73.7	7.39	270 000	300 000	9.8	x	x	x				
R 50 SH	2.00	50.8	30.99	29.21	17.81	45.50	47.8	65.1	73.6	8.10	385 000	415 000	11.5	x	x	x				

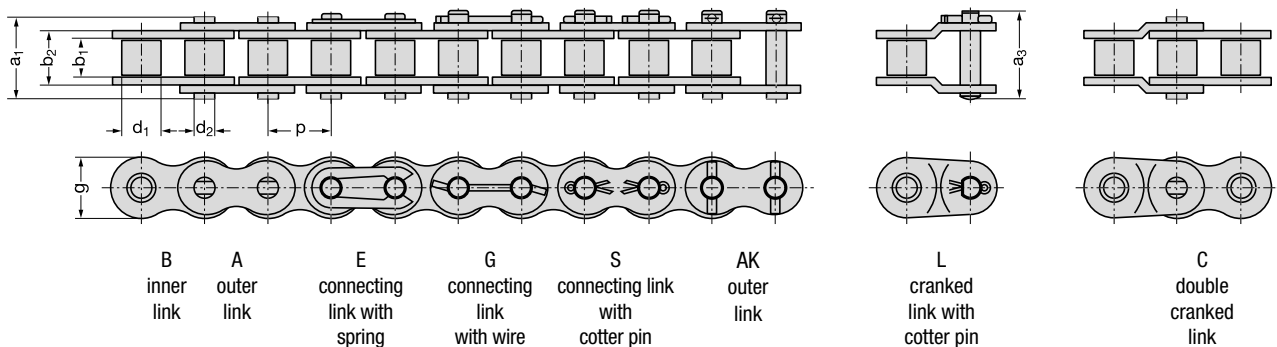

RexPro - X

Extreme Performance from Rexnord.

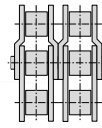

Duplex roller chains



Rexnord meets the requirements of Machine Directive 2006/42/EC



Applications & Characteristics

- For the heavy-duty drives and lifting purposes
- Extremely high loading capacity



Maintenance & Service life

- Excellent protection through RexPro lubrication
- Extremely robust
- Long service life



Eco-friendly

- Through RexPro lubrication
- Contains no heavy metals; Teflon and silicone free

Duplex roller chains for heavy-duty drives and lifting purposes

Chain No.	Pitch		Width between inner plates	Roller diameter	Pin diameter	Width over inner link	Link plate height	Transverse pitch	Connecting pin length	Bearing area	Minimum breaking load	Average tensile strength	Weight	Loose parts								
	inch	mm												b ₁ min	d ₁ max	d ₂ max	b ₂ max	g max	e	a ₃ max	A	F _u
			mm	mm	mm	mm	mm	mm	mm	mm	cm ²	N	N	kg/m								
R 25 - 2 SH	1.00	25.4	17.02	15.88	8.28	25.40	24.0	31.88	68.0	2.10	170 000	170 000	3.2	x	x	x					x	x
R 31 - 2 SH	1.25	31.75	19.56	19.05	10.19	32.00	29.2	42.00	88.0	3.25	260 000	300 000	5.3	x	x							x
R 38 - 2 SH	1.50	38.10	25.40	25.40	14.63	40.00	37.2	52.00	108.7	5.85	457 000	500 000	7.8	x	x							x
R 44 - 2 SH	1.75	44.45	30.99	27.94	15.90	46.50	40.8	61.20	127.5	7.39	465 000	525 000	9.8	x	x							x
R 50 - 2 SH	2.00	50.8	30.99	29.21	17.81	45.50	47.8	123.60	132.4	16.2	650 000	740 000	22.5	x	x							x

* also available as triplex on request

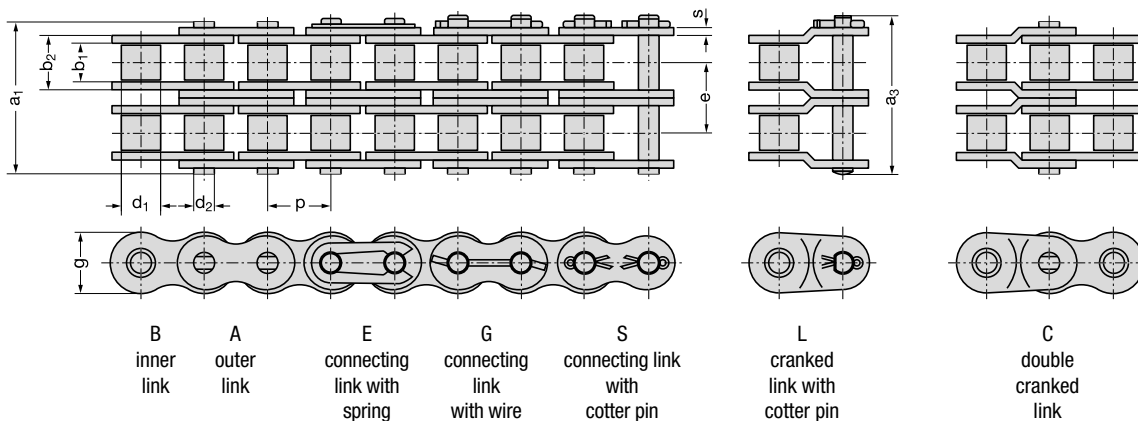

Extreme Performance from Rexnord

Expert chains with innovative technology and materials:

- Stainless steel
- Seamless rollers
- High-tech carbon sliding sleeves
- Food-grade lubricants
- Alloy surfaces
- Anti-friction coatings



	RexAthletic	RexCarbon	RexPlus	RexPlusCarbon	RexHiPro	RexProX
--	-------------	-----------	---------	---------------	----------	---------

Chain characteristics

Chain size	0,5" to 2"	0,5" to 1"	0,5" to 1"	0,5" to 1"	0,5" to 2"	0,5" to 2"
Maintenance level	low	zero	normal	zero	normal	low
Fatigue resistance	100%	100%	60%	60%	100%	100%
Tensile strength	100%	100%	60%	60%	100%	100%
Specific bearing load	100%	50%	50%	50%	100%	100%
Chain speed	up to 20 m/s	up to 20 m/s	up to 4 m/s	up to 2 m/s	up to 20 m/s	up to 20 m/s
Rust and acid resistant	no	no	damp	damp	partly	no

Environmental conditions

Temperature range	0° C to 120° C *	-40° C to 100° C *	-40° C to 120° C *	-40° C to 100° C *	-30° C to 130° C *	0° C to 120° C *
Damp, corrosive atmosphere	partly	partly	damp	damp	damp	partly
Dusty	partly	damp	damp	damp	partly	partly
Hygienic	NSF H2	NSF H1	NSF H1	NSF H1	NSF H2	NSF H2

An appropriate lubrication method should be selected, depending on chain speed.

These guideline values are valid for shock-free loading, a shaft centre distance of 40 x pitch, with the chain running over two sprockets and a number of teeth z1 = 21; z2 = 42. Other drive parameters can be determined using the Rexnord chain calculation program Rex®Drive.

*The temperature range can be extended by using special high- or low-temperature lubricants.

Overview Rexnord roller chains

Roller Chains

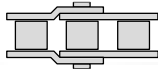

REXNORD

RexPro
RexPro lubrication
improved wear resistance
high fatigue resistance

- Outstanding protection against corrosion and wear
- Unique protection against chain joint stiffness
- Extremely eco-friendly

REXNORD

RexAthletic
good loading capacity
extended lubrication intervals

- Durable and low-maintenance
- Longer servicing intervals
- High loading capacity

REXNORD

RexCarbon
no lubrication
low noise

- Maintenance-free
- Low noise
- Eco-friendly

REXNORD

RexPlus
excellent corrosion resistance
high reliability

- Excellent resistance to rust and acids
- Highly reliable
- Fulfills hygiene requirements
- NSF H1 certification

REXNORD

RexPlusCarbon
no lubrication
excellent corrosion resistance

- Combination of RexPlus and RexCarbon
- Excellent resistance to rust and acids
- Maintenance-free
- NSF H1 certification

REXNORD

RexHiPro
good corrosion resistance
excellent loading capacity

- Outstanding corrosion resistance
- Long service life
- High loading capacity

Link-Belt
a brand of REXNORD

- The optimum choice for light and medium duty
- Good cost-benefit ratio
- High availability

REXNORD

RexProX
RexPro lubrication
improved wear resistance
high fatigue resistance

- Extremely high loading capacity
- Long service life
- Outstanding protection against corrosion and wear

Leaf Chains

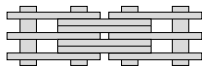

REXNORD

RexPro
RexPro lubrication
improved wear resistance
high fatigue resistance

- Outstanding protection against corrosion and wear
- Unique protection against chain joint stiffness
- Extremely eco-friendly

REXNORD

RexHiPro
good corrosion resistance
excellent loading capacity

- Outstanding corrosion resistance
- Long service life
- High loading capacity

REXNORD

RexAthletic
good loading capacity
extended lubrication intervals

- Durable and low-maintenance
- Longer servicing intervals
- High loading capacity

REXDL
a brand of REXNORD

- The optimum choice for light and medium duty
- Good cost-benefit ratio
- Good availability