



Approved Performance from Rexnord

Leaf chains BL Series | American type

REXDL
a brand of
REXNORD



Leaf chains - RexDL

Approved performance from Rexnord.

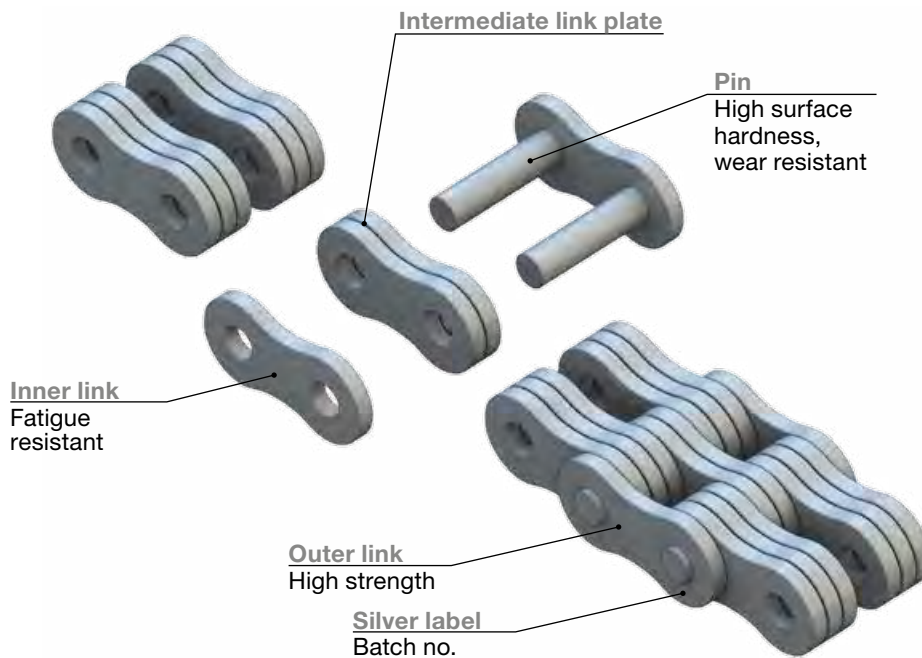

APPLICATIONS

- Light and medium lifting applications
- Telehandlers
- Material handling

CHARACTERISTICS

- Fulfils ISO quality requirements
- Rexnord guarantees delivery of the required performance
- Excellent corrosion resistance
- Established Rexnord brand

ADVANTAGES

- Good cost-benefit ratio
- Good availability
- Robust quality

LUBRICATION

- Contains no heavy metals
- Fulfils REACH requirements

RexDL - Leaf chains - Approved Performance from Rexnord



Proven performance

- Fulfils ISO quality requirements
- Rexnord guarantees the achievement of performance requirements
- optimum choice for light and medium duty applications



Purchasing policy

- Suppliers must comply with local environmental laws
- Suppliers are obliged to comply with Rexnord's ethical policy and internal guidelines
- Suppliers must consider local environmental policy



Economical

- Good cost-benefit ratio
- Good availability



Leaf chains - RexDL

Approved performance from Rexnord.



Proven performance

- Fulfils ISO quality requirements
- Rexnord guarantees the achievement of performance requirements
- optimum choice for light and medium duty applications



Purchasing policy

- Suppliers must comply with local environmental laws
- Suppliers are obliged to comply with Rexnord's ethical policy and internal guidelines
- Suppliers must consider local environmental policy



Economical

- Good cost-benefit ratio
- Good availability

RexDL - Leaf chains ISO 4347

Table 1 of 2

Chain no.	Chain designation	Pitch p nominal		Link plate combination	Pin Ø	Link plate height	Link plate thickness	Length over 100 pitches	Overall width	Bearing area	Clear width outer link	Required min. breaking strength ISO	Fatigue resistance	Weight						
		inch	mm																	
		d1 max.	g												s	■	B max.	A	b3 min.	F _B
mm	mm	mm	mm	mm	cm ²	mm	N	N	kg/m											
BL 422	LH 0822	0.5	12.7	2 x 2	5.09	12.07	2.08	1270	11.1	0.2	4.2	22 200	24 000	0.6						
BL 423	LH 0823			2 x 3											13.2	0.3	6.3	22 200	24 000	0.65
BL 434	LH 0834			3 x 4											17.4	0.41	10.5	33 400	36 000	0.9
BL 444	LH 0844			4 x 4											19.6	0.41	12.6	44 500	48 100	1.02
BL 446	LH 0846			4 x 6											23.8	0.61	16.8	44 500	48 100	1.26
BL 466	LH 0866			6 x 6											28.0	0.61	21.0	66 700	72 000	1.51
BL 523	LH 1023	0.625	15.875	2 x 3	5.96	15.09	2.48	1596	15.4	0.43	7.4	33 400	36 000	1.1						
BL 534	LH 1034			3 x 4											20.4	0.57	12.3	48 900	54 000	1.5
BL 544	LH 1044			4 x 4											22.8	0.57	14.7	66 700	72 000	1.8
BL 546	LH 1046			4 x 6											27.7	0.86	19.6	66 700	72 000	2.2
BL 566	LH 1066			6 x 6											32.7	0.86	24.5	100 100	108 000	2.6

Additional chain types on request

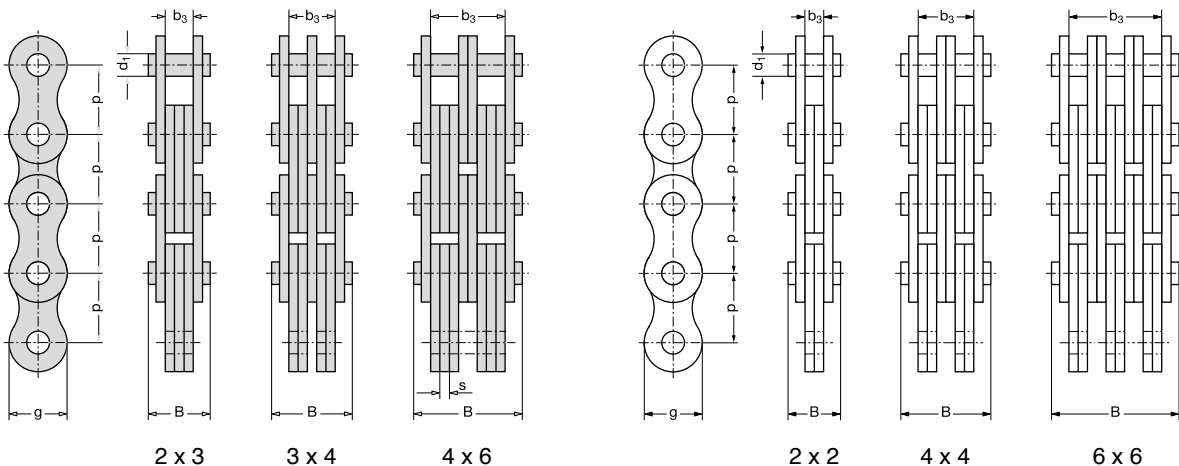

Leaf chains - RexDL

Approved performance from Rexnord.



Proven performance

- Fulfils ISO quality requirements
- Rexnord guarantees the achievement of performance requirements
- optimum choice for light and medium duty applications



Purchasing policy

- Suppliers must comply with local environmental laws
- Suppliers are obliged to comply with Rexnord's ethical policy and internal guidelines
- Suppliers must consider local environmental policy



Economical

- Good cost-benefit ratio
- Good availability

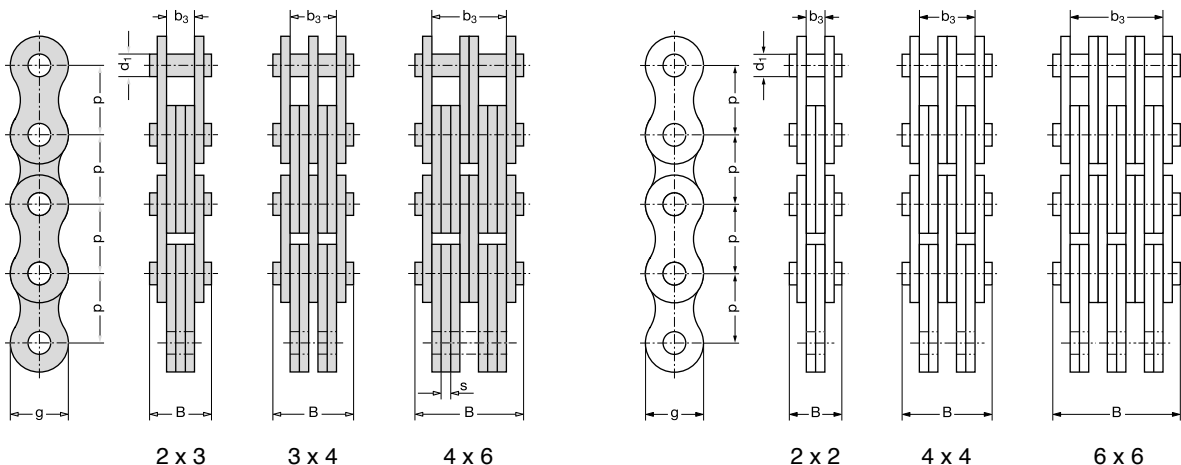

Table 2 of 2

RexDL - Leaf chains ISO 4347

Chain no.	Chain designation	Pitch p nominal		Link plate combination	Pin Ø	Link plate height	Link plate thickness	Length over 100 pitches	Overall width	Bearing area	Clear width outer link	Required min. breaking strength ISO	Fatigue resistance	Weight	
		inch	mm												d1 max.
BL 622	LH 1222	0.75	19.05	2 x 2	7.96	18.11	3.30	1905	17.4	0.51	6.4	48 900	55 800	1.5	
BL 623	LH 1223			2 x 3					20.8	0.74	9.6	48 900	55 800	1.8	
BL 634	LH 1234			3 x 4					27.5	0.98	16.0	75 600	83 700	2.5	
BL 644	LH 1244			4 x 4					30.8	0.98	19.3	97 900	111 600	2.9	
BL 646	LH 1246			4 x 6					37.5	1.47	25.8	97 900	111 600	3.6	
BL 666	LH 1266			6 x 6					44.2	1.47	32.2	146 800	167 400	4.3	
BL 822	LH 1622	1.00	25.4	2 x 2	9.56	24.13	4.09	2540	21.4	0.74	8.2	84500	94 500	2.4	
BL 823	LH 1623			2 x 3					25.5	1.14	12.3	84500	94 500	3.0	
BL 834	LH 1634			3 x 4					33.8	1.52	20.5	129000	142 200	4.2	
BL 844	LH 1644			4 x 4					37.9	1.52	24.6	169000	189 000	4.8	
BL 846	LH 1646			4 x 6					46.2	2.29	32.7	169000	189 000	6.0	
BL 866	LH 1666			6 x 6					54.5	2.29	41.1	253600	283 500	7.2	

Additional chain types on request



Recommended chain anchor dimensions for connecting leaf chain inner links

Chain no.	Inner link connector dimensions Dimensions in mm						
	f	b	c	d ₁	e	r ₁	r ₂
	max.	min.	max.	D 10	min.	max.	max.
BL 522	12.7	5.0	–	6.0	11.0	8.0	2.0
BL 523	14.9	7.5	–				2.0
BL 534	19.9	5.0	2.4				2.0
BL 544	22.4	5.0	4.8				2.0
BL 546	26.9	7.5	4.8				2.0
BL 566	31.9	5.0	4.8				2.0
BL 588	42.4	5.0	4.8				2.0
BL 623	19.9	10.3	–				5.0
BL 634	26.9	6.8	3.2	3.0			
BL 644	29.9	6.8	6.4	3.0			
BL 646	36.9	6.8	6.4	3.0			
BL 666	42.9	6.8	6.4	3.0			
BL 688	56.4	6.8	6.4	3.0			
BL 823	24.9	12.8	–	9.6	18.0	12.5	6.0
BL 834	32.9	8.5	4.0				4.0
BL 844	36.9	8.5	8.0				4.0
BL 846	45.9	12.8	8.0				6.0
BL 866	52.9	8.5	8.0				4.0
BL 888	69.4	8.5	8.0				4.0

Connecting pin for attaching leaf chains to chain anchor

Chain no.	Connecting pin order no.	Connecting pin dimensions Dimensions in mm			
		l min.	L max.	d max.	d ₂
		BL 522	709 – 355 – 22	12.8	19.4
BL 523	709 – 355 – 23	15.0	21.6		
BL 534	709 – 355 – 34	20.0	26.6		
BL 544	709 – 355 – 44	22.5	29.1		
BL 546	709 – 355 – 46	27.0	33.7		
BL 566	709 – 355 – 66	32.0	38.7		
BL 588	709 – 355 – 88	42.5	49.3		
BL 623	709 – 307 – 23	20.0	30.7	7.92	3.2
BL 634	709 – 307 – 34	27.0	37.7		
BL 644	709 – 307 – 44	30.0	40.7		
BL 646	709 – 307 – 46	37.0	47.7		
BL 666	709 – 307 – 66	43.0	53.7	9.53	3.2
BL 688	709 – 307 – 88	56.5	67.2		
BL 823	709 – 309 – 23	25.0	35.7		
BL 834	709 – 309 – 34	33.0	43.7		
BL 844	709 – 309 – 44	37.0	47.7		
BL 846	709 – 309 – 46	46.0	56.7		
BL 866	709 – 309 – 66	53.0	63.7		
BL 888	709 – 309 – 88	69.5	80.3		

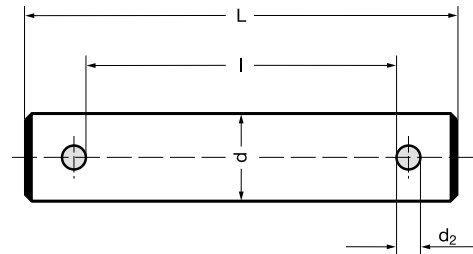
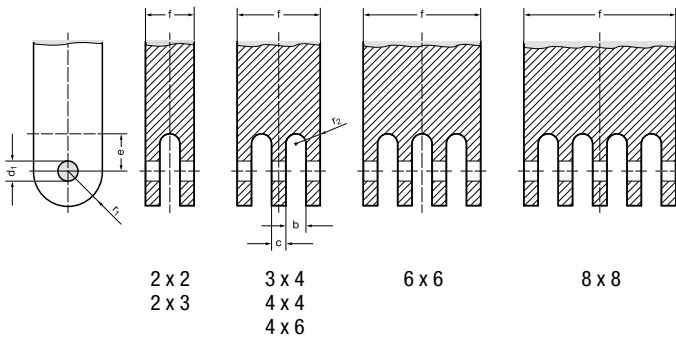

All pins are fitted with 2 cotters and – from BL 1234 and F 38 upwards – with 2 additional washers.

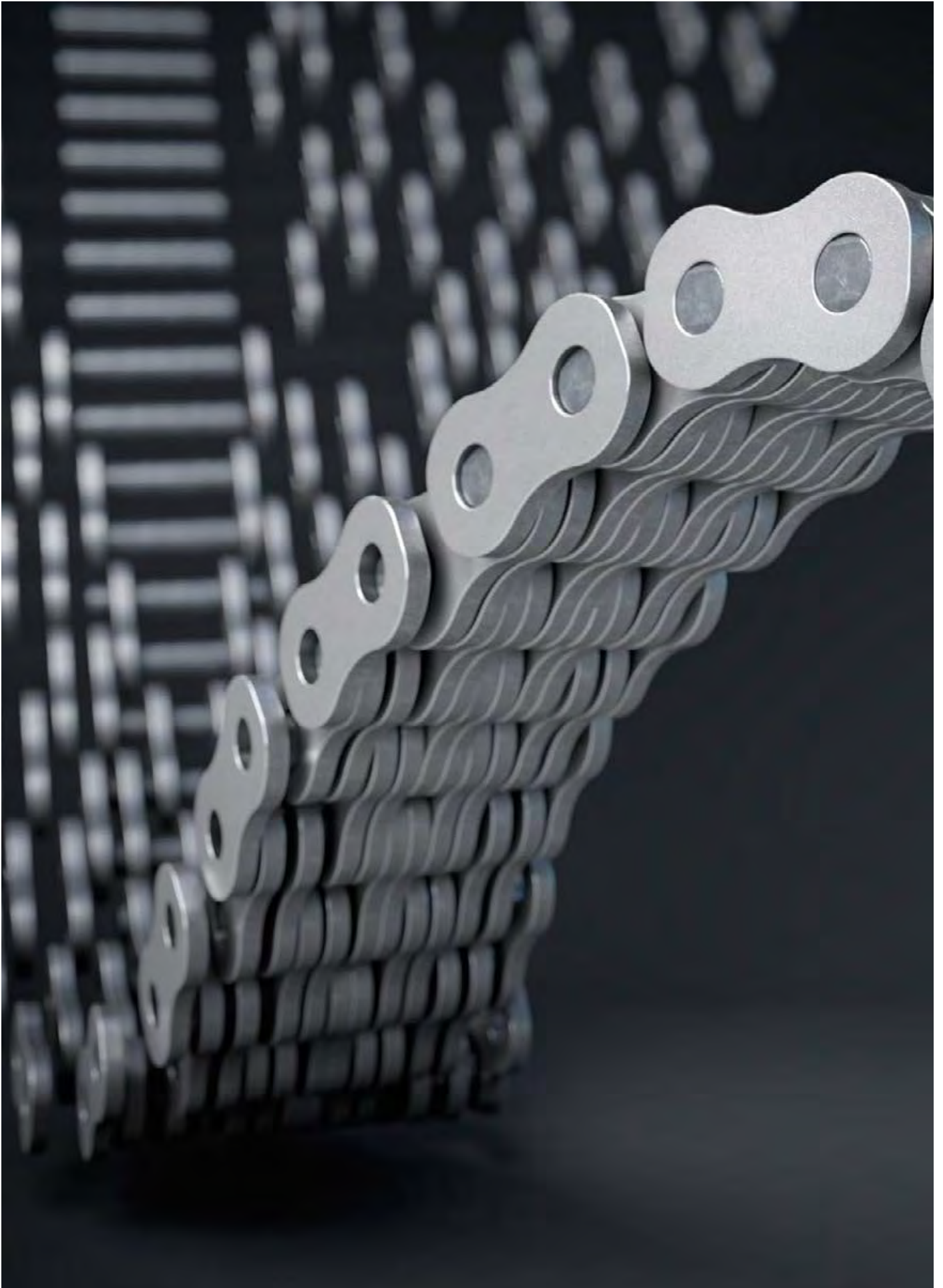

Overview Rexnord roller chains

Roller Chains

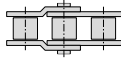

REXNORD

RexPro
RexPro lubrication
improved wear resistance
high fatigue resistance

- Outstanding protection against corrosion and wear
- Unique protection against chain joint stiffness
- Extremely eco-friendly

REXNORD

RexAthletic
good loading capacity
extended lubrication intervals

- Durable and low-maintenance
- Longer servicing intervals
- High loading capacity

REXNORD

RexCarbon
no lubrication
low noise

- Maintenance-free
- Low noise
- Eco-friendly

REXNORD

RexPlus
excellent corrosion resistance
high reliability

- Excellent resistance to rust and acids
- Highly reliable
- Fulfills hygiene requirements
- NSF H1 certification

REXNORD

RexPlusCarbon
no lubrication
excellent corrosion resistance

- Combination of RexPlus and RexCarbon
- Excellent resistance to rust and acids
- Maintenance-free
- NSF H1 certification

REXNORD

RexHiPro
good corrosion resistance
excellent loading capacity

- Outstanding corrosion resistance
- Long service life
- High loading capacity

Link-Belt
a brand of REXNORD

- The optimum choice for light and medium duty
- Good cost-benefit ratio
- High availability

REXNORD

RexProX
RexPro lubrication
improved wear resistance
high fatigue resistance

- Extremely high loading capacity
- Long service life
- Outstanding protection against corrosion and wear

Flyer Chains

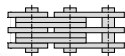

REXNORD

RexPro
RexPro lubrication
improved wear resistance
high fatigue resistance

- Outstanding protection against corrosion and wear
- Unique protection against chain joint stiffness
- Extremely eco-friendly

REXNORD

RexHiPro
good corrosion resistance
excellent loading capacity

- Outstanding corrosion resistance
- Long service life
- High loading capacity

REXNORD

RexDura
improved wear resistance
lubrication stay in chain hinge

- Durable and low-maintenance
- Longer servicing intervals
- High loading capacity
- Extreme wear resistance for double-length service life

REXDL
a brand of REXNORD

- The optimum choice for light and medium duty
- Good cost-benefit ratio
- Good availability